

Choose the language

English

Italiano

Deutsch

Français

Español

be-Easy slatted Sizes

Table

Depth 79 cm
Depth 31 1/8"

79

80 cm
31 1/8"

 → Teak

160 cm
63"

 → Teak

180 cm
70 7/8"

 → Teak

200 cm
78 6/8"

 → Teak

220 cm
86 5/8"

 → Teak

Depth 99 cm
Depth 39"

99

100 cm
39 3/8"

 → Teak

160 cm
63"

 → Teak

180 cm
70 7/8"

 → Teak

200 cm
78 6/8"

 → Teak

220 cm
86 5/8"

 → Teak

Depth 139cm
Depth 54 6/8"

139

140 cm
55 1/8"

 → Teak

Bench

Depth 40 cm
Depth 15 6/8"

40

140 cm
55 1/8"

 → Teak

160 cm
63"

 → Teak

180 cm
70 7/8"

 → Teak

200 cm
78 6/8"

 → Teak

Bar counter

Depth 59 cm
Depth 23 2/8"

59

160 cm
63"

 → Teak

180 cm
70 7/8"

 → Teak

200 cm
78 6/8"

 → Teak

220 cm
86 5/8"

 → Teak

Depth 79 cm
Depth 31 1/8"

79

160 cm
63"

 → Teak

180 cm
70 7/8"

 → Teak

200 cm
78 6/8"

 → Teak

220 cm
86 5/8"

 → Teak

Tops 20 mm thick

Occasional table

79

80 cm
31 4/8"

 → Teak

99

100 cm
39 3/8"

 → Teak

Teak

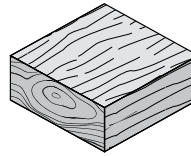

Over time, untreated teak will acquire a typical silvery colour characteristic of this wood finish when exposed to the open air. This aesthetic process does not affect the quality or the resistance of the material.

For regular cleaning operations, use a detergent for outdoor furniture made of wood, or simply use a soft brush and water.

ICADECK (water-based oil) can be applied to prevent oxidation of the surface of the new product.

To remove the grey patina caused by oxidation and restore the original colour of the teak, use **CLEANDECK** (anti-grey detergent). Treatment with **CLEANDECK** must be followed by washing and applying **ICADECK** to a dry surface

Do not use a high-pressure cleaner, as it would damage the wood surface and fibres. To remove surface scratches, you can use sandpaper or a manual sander.

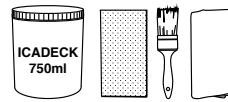

ICADECK KIT

ICADECK + abrasive sponge + brush + cloth



ICADECK



CLEANDECK

Code		Price in EURO	Packs	Vol ³	Kg
02KITOUT01	ICADECK KIT (water-based oil)		1	0,01	2
02KITOUT02	ICADECK (water-based oil)		1	0,01	1,5
02KITOUT03	CLEANDECK (anti-grey detergent)		1	0,01	1,5

be-Easy slatted Table/Bench

Finish of structure:

Anodised aluminium

Leg finish:

White painted steel" (similar to RAL 9016)

"Fenix-NTM® Grigio Londra" painted steel (similar to RAL Design 0805005)

Black painted steel" (similar to RAL 9004)

Olive Green painted steel (colour ref. "Olive Green Polyurethane PO08")

Finish of top:

Teak

→ Depth = # slats

P 40 cm (15 5/8") = 2 slats

P 59 cm (23 2/8") = 3 slats

P 79 cm (31 1/8") = 4 slats

P 99 cm (39") = 5 slats

P 139 cm (54 6/8") = 7 slats

→ Reinforced packaging, see inside of cover.

→ "Casper" protective cover, see page 74.

Table

Code	Length (L)	Depth	Legs	Top	Price in EURO	Packs	Vol.³	Kg
01BEA30F	80	79	painted	Teak		1	0,19	27
01BEA31F	160	79	painted	Teak		1	0,37	42
01BEA32F	180	79	painted	Teak		1	0,39	44
01BEA33F	200	79	painted	Teak		1	0,45	48
01BEA34F	220	79	painted	Teak		1	0,49	52
01BEA37F	100	99	painted	Teak		1	0,25	42
01BEA38F	160	99	painted	Teak		1	0,45	54
01BEA39F	180	99	painted	Teak		1	0,48	56
01BEA40F	200	99	painted	Teak		1	0,55	63
01BEA41F	220	99	painted	Teak		1	0,59	67
01BEA44F	140	139	painted	Teak		1	0,55	67

Bench

Code	Length (L)	Depth	Legs	Top	Price in EURO	Packs	Vol.³	Kg
23BEA01	140	40	painted	Teak		1	0,18	23
23BEA02	160	40	painted	Teak		1	0,20	24
23BEA03	180	40	painted	Teak		1	0,23	26
23BEA04	200	40	painted	Teak		1	0,25	28

Optionals

Code		Price in EURO	Packs	Vol.³	Kg
02GTA02		legs height cut to size	-	-	-

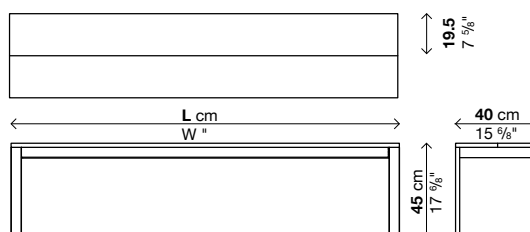
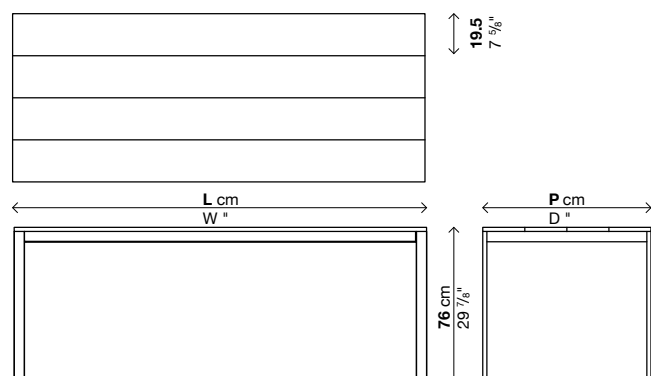

be-Easy slatted Bar counter/Occasional table

Finish of structure:

Anodised aluminium

Leg finish:

White painted steel" (similar to RAL 9016)

"Fenix-NTM® Grigio Londra" painted steel (similar to RAL Design 0805005)

Black painted steel" (similar to RAL 9004)

Olive Green painted steel (colour ref. "Olive Green Polyurethane PO08")

Finish of top:

Teak

→ Depth = # slats

P 40 cm (15 5/8") = 2 slats

P 59 cm (23 2/8") = 3 slats

P 79 cm (31 1/8") = 4 slats

P 99 cm (39") = 5 slats

P 139 cm (54 6/8") = 7 slats

→ Reinforced packaging, see inside of cover.

→ "Casper" protective cover, see page 74.

Bar counter

Code	Length (L)	Depth	Legs	Top	Price in EURO	Packs	Vol.³	Kg
24BEA01	160	59	painted	Teak		1	0,31	45
24BEA02	180	59	painted	Teak		1	0,34	47
24BEA03	200	59	painted	Teak		1	0,38	49
24BEA04	220	59	painted	Teak		1	0,41	54
24BEA07	160	79	painted	Teak		1	0,40	50
24BEA08	180	79	painted	Teak		1	0,44	54
24BEA09	200	79	painted	Teak		1	0,48	59
24BEA10	220	79	painted	Teak		1	0,52	65

Optionals

Code		Price in EURO	Packs	Vol.³	Kg
02GTA02	 legs height cut to size		-	-	-

Occasional table

Code	Length (L)	Depth	H.	Legs	Top	Price in EURO	Packs	Vol.³	Kg
01BEA50F	80	79	20	painted	Teak		1	0,19	22
01BEA51F	100	99	20	painted	Teak		1	0,25	37
01BEA52F	80	79	35	painted	Teak		1	0,19	24
01BEA53F	100	99	35	painted	Teak		1	0,25	39

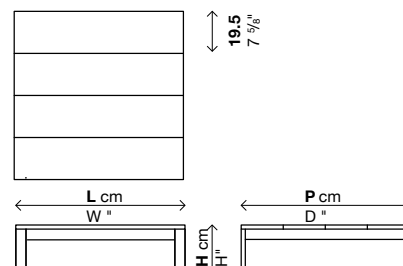
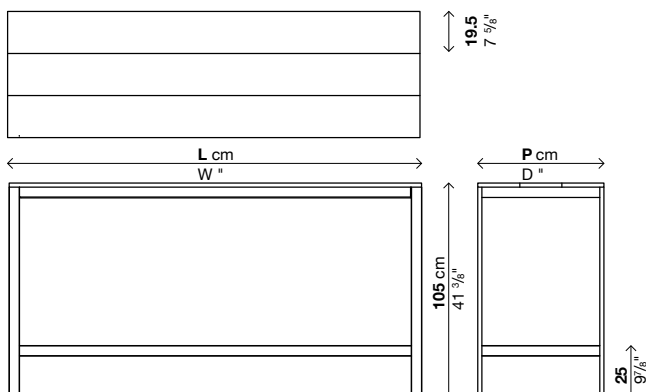

be-Easy slatted

Legenda dimensioni

Tavolo

Prof. 79 cm
Depth 31 1/8"

79

80 cm
31 1/8"

 → Teak

160 cm
63"

 → Teak

180 cm
70 7/8"

 → Teak

200 cm
78 6/8"

 → Teak

220 cm
86 5/8"

 → Teak

Prof. 99 cm
Depth 39"

99

100 cm
39 3/8"

 → Teak

160 cm
63"

 → Teak

180 cm
70 7/8"

 → Teak

200 cm
78 6/8"

 → Teak

220 cm
86 5/8"

 → Teak

Prof. 139cm
Depth 54 6/8"

139

140 cm
55 1/8"

 → Teak

Panchetta

Prof. 40 cm
Depth 15 6/8"

40

140 cm
55 1/8"

 → Teak

160 cm
63"

 → Teak

180 cm
70 7/8"

 → Teak

200 cm
78 6/8"

 → Teak

Bancone

Prof. 59 cm
Depth 23 2/8"

59

160 cm
63"

 → Teak

180 cm
70 7/8"

 → Teak

200 cm
78 6/8"

 → Teak

220 cm
86 5/8"

 → Teak

Prof. 79 cm
Depth 31 1/8"

79

160 cm
63"

 → Teak

180 cm
70 7/8"

 → Teak

200 cm
78 6/8"

 → Teak

220 cm
86 5/8"

 → Teak

Piani Sp. 20 mm

Tavolino

79 80 cm
31 4/8" → Teak

99 100 cm
39 3/8" → Teak

Teak

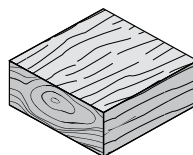

Con il passare del tempo, il teak non trattato otterrà il tipico colore argenteo che caratterizza questa essenza all'aria aperta. Questo processo estetico non ha alcuna influenza sulla qualità o la resistenza del materiale.

Per la normale pulizia del teak si può utilizzare un detergente per mobili in legno da esterni, oppure semplicemente una spazzola a setole morbide e dell'acqua.

Per evitare l'ossidazione superficiale del prodotto nuovo è possibile applicare **ICADECK** (olio all'acqua).

Per rimuovere la patina grigia dovuta all'ossidazione e ripristinare il colore originale del teak, utilizzare **CLEANECK** (detergente antigrigio). Il trattamento con **CLEANECK** deve essere seguito da un lavaggio e dall'applicazione di **ICADECK** su superficie asciutta.

Non usare l'idropulitrice che danneggerebbe la superficie e le fibre del legno. Per eliminare graffi superficiali si può usare della carta abrasiva oppure una levigatrice a mano.

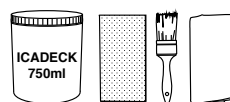

KIT ICADECK

ICADECK + spugna abrasiva + pennello + panno



ICADECK



CLEANECK

Codice	Prezzi EURO	colli: m ³ : Kg
02KITOUT01 KIT ICADECK (olio all'acqua)		1 0,01: 2
02KITOUT02 ICADECK (olio all'acqua)		1 0,01: 1,5
02KITOUT03 CLEANDECK (detergente antigrigio)		1 0,01: 1,5

be-Easy slatted Tavolo/Panchetta

Finitura struttura:

Alluminio anodizzato

Finitura gambe:

Acciaio verniciato bianco (simile al Ral 9016)

Acciaio verniciato "Grigio Londra Fenix-NTM®" (simile al Ral Design0805005)

Acciaio verniciato nero (simile al Ral 9004)

Acciaio verniciato verde oliva (rif. colore "Poliuretano verde oliva PO08")

Finitura piano:

Teak

→ **Profondità = # doghe**

P 40 cm (15 5/8") = 2 doghe

P 59 cm (23 2/8") = 3 doghe

P 79 cm (31 1/8") = 4 doghe

P 99 cm (39") = 5 doghe

P 139 cm (54 6/8") = 7 doghe

→ *Imballi rinforzati vedi interno di copertina.*

→ **Copertura protettiva "Casper" vedi pag. 74.**

Tavolo

Codice	Lunghezza (L)	Prof.	Gambe	Piano	Prezzi EURO	coll.	m ³	Kg
01BEA30F	80	79	verniciato	teak		1	0,19	27
01BEA31F	160	79	verniciato	teak		1	0,37	42
01BEA32F	180	79	verniciato	teak		1	0,39	44
01BEA33F	200	79	verniciato	teak		1	0,45	48
01BEA34F	220	79	verniciato	teak		1	0,49	52
01BEA37F	100	99	verniciato	teak		1	0,25	42
01BEA38F	160	99	verniciato	teak		1	0,45	54
01BEA39F	180	99	verniciato	teak		1	0,48	56
01BEA40F	200	99	verniciato	teak		1	0,55	63
01BEA41F	220	99	verniciato	teak		1	0,59	67
01BEA44F	140	139	verniciato	teak		1	0,55	67

Panchetta

Codice	Lunghezza (L)	Prof.	Gambe	Piano	Prezzi EURO	coll.	m ³	Kg
23BEA01	140	40	verniciato	teak		0	0,18	23
23BEA02	160	40	verniciato	teak		0	0,20	24
23BEA03	180	40	verniciato	teak		0	0,23	26
23BEA04	200	40	verniciato	teak		0	0,25	28

Optionals

Codice		Prezzi EURO	coll.	m ³	Kg
02GTA02	 taglio gambe a misura	-	-	-	-

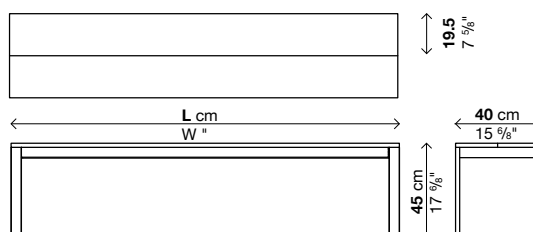
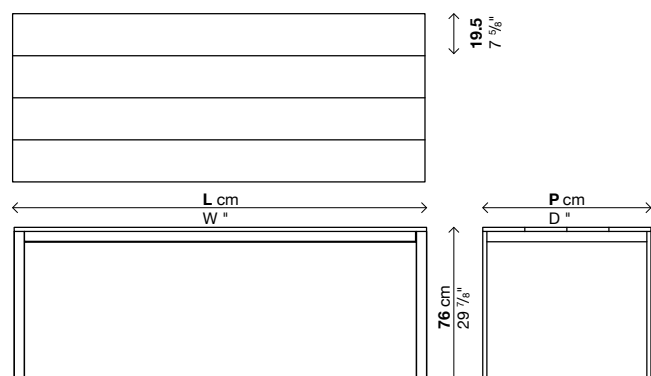

be-Easy slatted Bancone/Tavolino

Finitura struttura:

Alluminio anodizzato

Finitura gambe:

Acciaio verniciato bianco (simile al Ral 9016)

Acciaio verniciato "Grigio Londra Fenix-NTM®" (simile al Ral Design0805005)

Acciaio verniciato nero (simile al Ral 9004)

Acciaio verniciato verde oliva (rif. colore "Poliuretano verde oliva PO08")

Finitura piano:

Teak

→ **Profondità = # doghe**

P 40 cm (15⁵/₈") = 2 doghe

P 59 cm (23²/₈") = 3 doghe

P 79 cm (31¹/₈") = 4 doghe

P 99 cm (39") = 5 doghe

P 139 cm (54⁶/₈") = 7 doghe

→ *Imballi rinforzati vedi interno di copertina.*

→ **Copertura protettiva "Casper" vedi pag. 74.**

Bancone

Codice	Lunghezza (L)	Prof.	Gambe	Piano	Prezzi EURO	coll.	m ³	Kg
24BEA01	160	59	verniciato	teak		1	0,31	45
24BEA02	180	59	verniciato	teak		1	0,34	47
24BEA03	200	59	verniciato	teak		1	0,38	49
24BEA04	220	59	verniciato	teak		1	0,41	54
24BEA07	160	79	verniciato	teak		1	0,40	50
24BEA08	180	79	verniciato	teak		1	0,44	54
24BEA09	200	79	verniciato	teak		1	0,48	59
24BEA10	220	79	verniciato	teak		1	0,52	65

Optionals

Codice		Prezzi EURO	coll.	m ³	Kg
02GTA02	 taglio gambe a misura	-	-	-	-

Tavolino

Codice	Lunghezza (L)	Prof.	Alt.	Gambe	Piano	Prezzi EURO	coll.	m ³	Kg
01BEA50F	80	79	20	verniciato	teak		1	0,19	22
01BEA51F	100	99	20	verniciato	teak		1	0,25	37
01BEA52F	80	79	35	verniciato	teak		1	0,19	24
01BEA53F	100	99	35	verniciato	teak		1	0,25	39

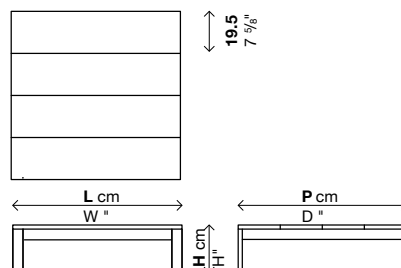
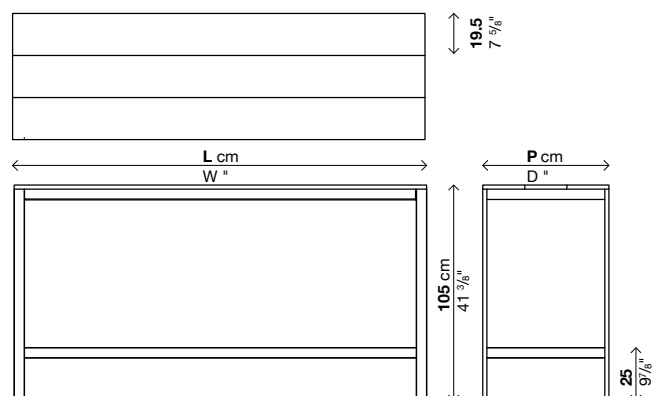

be-Easy slatted Größenübersicht

Tisch

Breite 79 cm
Breite 31 1/8"

79

80 cm
31 1/8"

 → Teak

160 cm
63"

 → Teak

180 cm
70 7/8"

 → Teak

200 cm
78 6/8"

 → Teak

220 cm
86 5/8"

 → Teak

Breite 99 cm
Breite 39"

99

100 cm
39 3/8"

 → Teak

160 cm
63"

 → Teak

180 cm
70 7/8"

 → Teak

200 cm
78 6/8"

 → Teak

220 cm
86 5/8"

 → Teak

Breite 139cm
Breite 54 6/8"

139

140 cm
55 1/8"

 → Teak

Sitzbank

Breite 40 cm
Breite 15 6/8"

40

140 cm
55 1/8"

 → Teak

160 cm
63"

 → Teak

180 cm
70 7/8"

 → Teak

200 cm
78 6/8"

 → Teak

Theke

Breite 59 cm
Breite 23 2/8"

59

160 cm
63"

 → Teak

180 cm
70 7/8"

 → Teak

200 cm
78 6/8"

 → Teak

220 cm
86 5/8"

 → Teak

Breite 79 cm
Breite 31 1/8"

79

160 cm
63"

 → Teak

180 cm
70 7/8"

 → Teak

200 cm
78 6/8"

 → Teak

220 cm
86 5/8"

 → Teak

Platten St. 20 mm

Beistelltisch

79 80 cm
31 1/8" → Teak

99 100 cm
39 3/8" → Teak

Teak

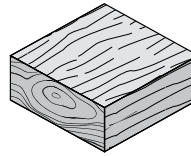

Im Laufe der Zeit erhält nicht behandeltes Teakholz jene typische silbergraue Patina, die dieses Holz im Freien auszeichnet. Dieser das Aussehen betreffende Prozess hat keinerlei Auswirkungen auf die Qualität oder die Widerstandsfähigkeit des Materials.

Für die normale Reinigung von Teakholz können ein Reinigungsmittel für Gartenmöbel aus Holz oder einfach eine weiche Bürste und Wasser eingesetzt werden.

Um eine oberflächliche Oxidation des neuen Produkts zu verhindern, kann eine Schicht **ICADECK** (Öl auf Wasserbasis) aufgetragen werden.

Um die durch Oxidierung entstandene graue Patina zu entfernen und die ursprüngliche Farbe des Teakholzes wieder herzustellen, wird die Verwendung von **CLEANDECK** (Anti-Grau-Reinigungsmittel) empfohlen. Nach der Reinigung mit **CLEANDECK** muss das Holz gewaschen und die trockene Oberfläche mit einer Schicht **ICADECK** behandelt werden.

Verwenden Sie keinen Hochdruckreiniger, da dieser die Oberfläche und die Holzfasern beschädigen würde. Leichte Kratzspuren lassen sich mit Schleifpapier oder einem Handschleifgerät entfernen.

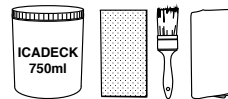

PFLEGESET ICADECK

ICADECK + Reibschwamm + Pinsel + Tuch



ICADECK



CLEANDECK

Art.-Nr.		Preis in EURO	Kolli	V.m ³	Kg
02KITOUT01	PFLEGESET ICADECK (Öl auf Wasserbasis)		1	0,01	2
02KITOUT02	ICADECK (Öl auf Wasserbasis)		1	0,01	1,5
02KITOUT03	CLEANDECK (Anti-Grau-Reinigungsmittel)		1	0,01	1,5

be-Easy slatted Tisch/Sitzbank

Strukturausführung:

Eloxiertes Aluminium

Ausführung der Beine:

Weiß lackierter Stahl (farbähnlich wie Ral 9016)

Lackierter Stahl "Grau London Fenix-NTM®" (farbähnlich wie Ral Design0805005)

Schwarz lackierter Stahl (farbähnlich wie Ral 9004)

Olivgrün lackierter Stahl (farbähnlich wie "Polyurethan Olivgrün PO08")

Ausführung der Tischplatte:

Teak

→ Tiefe = # Leisten

P 40 cm (15 5/8") = 2 Leisten

P 59 cm (23 2/8") = 3 Leisten

P 79 cm (31 1/8") = 4 Leisten

P 99 cm (39") = 5 Leisten

P 139 cm (54 6/8") = 7 Leisten

→ Für verstärkte Verpackungen siehe Innenseite des Umschlags.

→ **Schutzhülle "Casper" siehe Seite 74.**

Tisch

Art.-Nr.	Länge (L)	Breite	Beine	Platte	Preis in EURO	Kolli	V.m ³	Kg
01BEA30F	80	79	lackiert	teak		1	0,19	27
01BEA31F	160	79	lackiert	teak		1	0,37	42
01BEA32F	180	79	lackiert	teak		1	0,39	44
01BEA33F	200	79	lackiert	teak		1	0,45	48
01BEA34F	220	79	lackiert	teak		1	0,49	52
01BEA37F	100	99	lackiert	teak		1	0,25	42
01BEA38F	160	99	lackiert	teak		1	0,45	54
01BEA39F	180	99	lackiert	teak		1	0,48	56
01BEA40F	200	99	lackiert	teak		1	0,55	63
01BEA41F	220	99	lackiert	teak		1	0,59	67
01BEA44F	140	139	lackiert	teak		1	0,55	67

Sitzbank

Art.-Nr.	Länge (L)	Breite	Beine	Platte	Preis in EURO	Kolli	V.m ³	Kg
23BEA01	140	40	lackiert	teak		1	0,18	23
23BEA02	160	40	lackiert	teak		1	0,20	24
23BEA03	180	40	lackiert	teak		1	0,23	26
23BEA04	200	40	lackiert	teak		1	0,25	28

Optionals

Art.-Nr.		Preis in EURO	Kolli	V.m ³	Kg
02GTA02	 Zuschnitt der Beine nach Maß		-	-	-

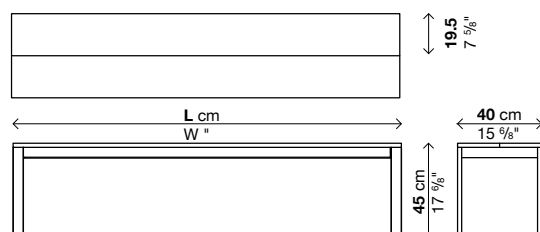
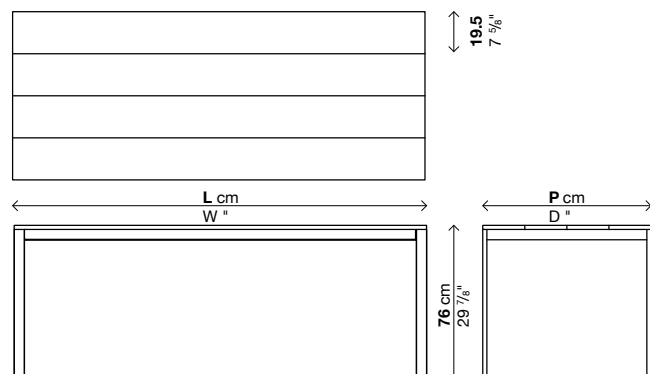

be-Easy slatted Theke/Beistelltisch

Strukturausführung:

Eloxiertes Aluminium

Ausführung der Beine:

Weiß lackierter Stahl (farbähnlich wie Ral 9016)

Lackierter Stahl "Grau London Fenix-NTM®" (farbähnlich wie Ral Design0805005)

Schwarz lackierter Stahl (farbähnlich wie Ral 9004)

Olivgrün lackierter Stahl (farbähnlich wie "Polyurethan Olivgrün PO08")

Ausführung der Tischplatte:

Teak

→ Tiefe = # Leisten

P 40 cm (15 5/8") = 2 Leisten

P 59 cm (23 2/8") = 3 Leisten

P 79 cm (31 1/8") = 4 Leisten

P 99 cm (39") = 5 Leisten

P 139 cm (54 6/8") = 7 Leisten

→ Für verstärkte Verpackungen siehe Innenseite des Umschlags.

→ **Schutzhülle "Casper" siehe Seite 74.**

Theke

Art.-Nr.	Länge (L)	Breite	Beine	Platte	Preis in EURO	Kolli	V.m ³	Kg
24BEA01	160	59	lackiert	teak		1	0,31	45
24BEA02	180	59	lackiert	teak		1	0,34	47
24BEA03	200	59	lackiert	teak		1	0,38	49
24BEA04	220	59	lackiert	teak		1	0,41	54
24BEA07	160	79	lackiert	teak		1	0,40	50
24BEA08	180	79	lackiert	teak		1	0,44	54
24BEA09	200	79	lackiert	teak		1	0,48	59
24BEA10	220	79	lackiert	teak		1	0,52	65

Optionals

Art.-Nr.		Preis in EURO	Kolli	V.m ³	Kg
02GTA02	 Zuschnitt der Beine nach Maß		-	-	-

Beistelltisch

Art.-Nr.	Länge (L)	Breite	Beine	Platte	Preis in EURO	Kolli	V.m ³	Kg
01BEA50F	80	79	20	lackiert	teak	1	0,19	22
01BEA51F	100	99	20	lackiert	teak	1	0,25	37
01BEA52F	80	79	35	lackiert	teak	1	0,19	24
01BEA53F	100	99	35	lackiert	teak	1	0,25	39

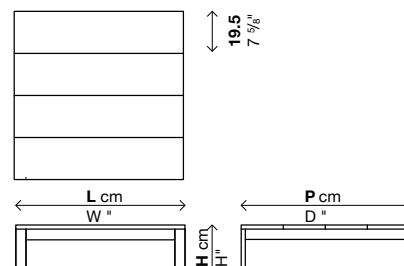
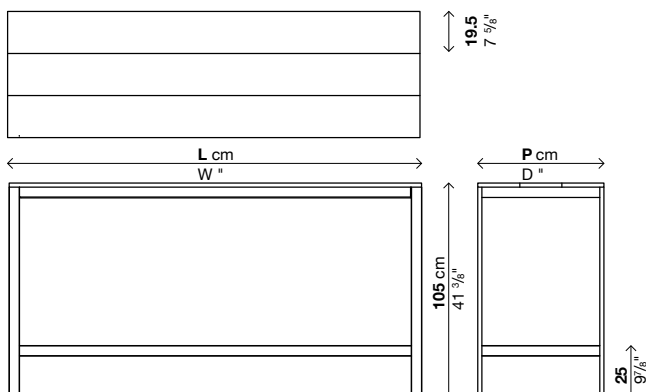

be-Easy slatted

Dimensions

Table

Prof. 79 cm
Prof. 31 1/8"

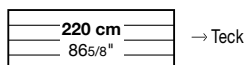
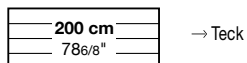
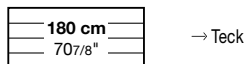
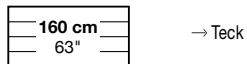

Prof. 99 cm
Prof. 39"

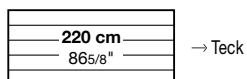
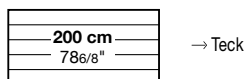
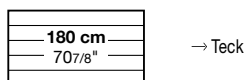
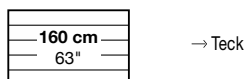
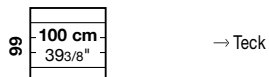

Prof. 139cm
Prof. 54 6/8"

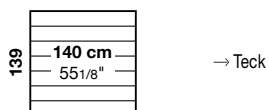

Banc

Prof. 40 cm
Prof. 15 6/8"

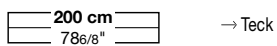
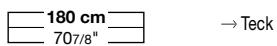
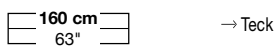
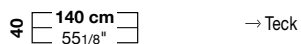
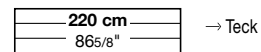
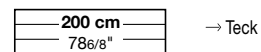
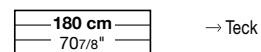
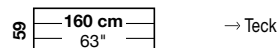
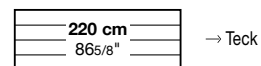
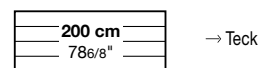
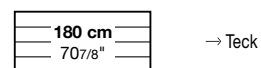
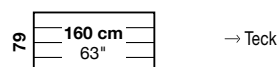

Table bar haute

Prof. 59 cm
Prof. 23 2/8"



Prof. 79 cm
Prof. 31 1/8"



Plateaux Ép. 20 mm

Table basse

79 80 cm
31 1/8" → Teck

99 100 cm
39 3/8" → Teck

Teck

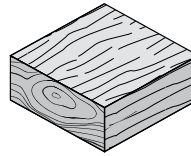

Au fil des années, le teck non traité obtiendra sa typique couleur argentée qui caractérise cette essence lorsqu'on la laisse à l'extérieur. Cette transformation esthétique ne modifie aucunement la qualité ou la résistance de ce matériau.

Pour le nettoyage courant du teck, on pourra utiliser un nettoyant pour meubles d'extérieur en bois ou bien tout simplement une brosse à poils souples et de l'eau.

Pour éviter que la surface du produit neuf s'oxyde, il est possible d'appliquer **ICADECK** (huile à base d'eau).

Pour éliminer la patine grise dérivant de l'oxydation de la surface et rétablir la couleur d'origine du teck, utiliser **CLEANDECK** (nettoyant anti-gris). Le traitement avec le produit **CLEANDECK** doit être suivi d'un lavage puis de l'application du produit **ICADECK** une fois que la surface sera bien sèche.

Ne pas utiliser de nettoyeur à haute pression qui pourrait endommager la surface et les fibres du bois. Pour éliminer les rayures en surface, on pourra utiliser du papier de verre ou bien une cale à poncer.

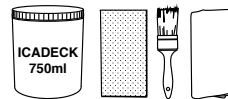

KIT ICADECK

ICADECK + éponge abrasive + pinceau + chiffon



ICADECK



CLEANDECK

Code	Prix en EURO	Coils	m ²	Kg
02KITOUT01 KIT ICADECK (huile à base d'eau)		1	0,01	2
02KITOUT02 ICADECK (huile à base d'eau)		1	0,01	1,5
02KITOUT03 CLEANDECK (nettoyant anti-gris)		1	0,01	1,5

be-Easy slatted Table/Banquette

Finition de la structure:

Aluminium anodisé

Finition piètement:

Acier laqué blanc (semblable à la teinte Ral 9016)

Acier laqué "gris Londres Fenix-NTM®" (semblable à la teinte Ral Design0805005)

Acier laqué noir (semblable à la teinte Ral 9004)

Acier laqué vert olive (réf. coloris "Polyuréthane vert olive PO08")

Finition du plateau:

Teck

→ **Profondeur = # lattes**

P 40 cm (15 5/8") = 2 lattes

P 59 cm (23 2/8") = 3 lattes

P 79 cm (31 1/8") = 4 lattes

P 99 cm (39") = 5 lattes

P 139 cm (54 6/8") = 7 lattes

→ Pour emballages renforcés, voir intérieur de la couverture.

→ **Housse de protection "Casper", voir page 74.**

Table

Code	Longueur (L)	Prof.	Pieds	Plateau	Prix en EURO	Coûts	m ²	Kg
01BEA30F	80	79	laqué	Teck		1	0,19	27
01BEA31F	160	79	laqué	Teck		1	0,37	42
01BEA32F	180	79	laqué	Teck		1	0,39	44
01BEA33F	200	79	laqué	Teck		1	0,45	48
01BEA34F	220	79	laqué	Teck		1	0,49	52
01BEA37F	100	99	laqué	Teck		1	0,25	42
01BEA38F	160	99	laqué	Teck		1	0,45	54
01BEA39F	180	99	laqué	Teck		1	0,48	56
01BEA40F	200	99	laqué	Teck		1	0,55	63
01BEA41F	220	99	laqué	Teck		1	0,59	67
01BEA44F	140	139	laqué	Teck		1	0,55	67

Optionals

Code		Prix en EURO	Coûts	m ²	Kg
02GTA02	 coupe des pieds sur mesure		-	-	-

Banc

Code	Longueur (L)	Prof.	Pieds	Plateau	Prix en EURO	Coûts	m ²	Kg
23BEA01	140	40	laqué	Teck		1	0,18	23
23BEA02	160	40	laqué	Teck		1	0,20	24
23BEA03	180	40	laqué	Teck		1	0,23	26
23BEA04	200	40	laqué	Teck		1	0,25	28

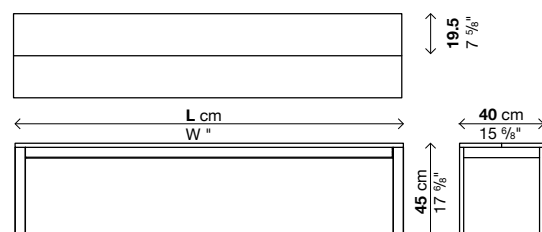
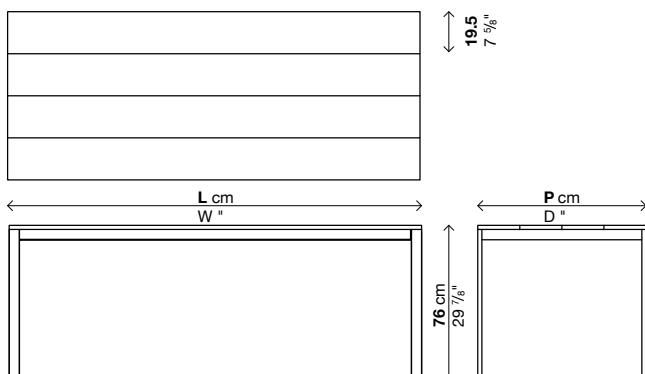

be-Easy slatted

Table bar haute/Table basse

Finition de la structure:

Aluminium anodisé

Finition piètement:

Acier laqué blanc (semblable à la teinte Ral 9016)

Acier laqué "gris Londres Fenix-NTM®" (semblable à la teinte Ral Design0805005)

Acier laqué noir (semblable à la teinte Ral 9004)

Acier laqué vert olive (réf. coloris "Polyuréthane vert olive PO08")

Finition du plateau:

Teck

→ **Profondeur = # lattes**

P 40 cm (15 5/8") = 2 lattes

P 59 cm (23 2/8") = 3 lattes

P 79 cm (31 1/8") = 4 lattes

P 99 cm (39") = 5 lattes

P 139 cm (54 6/8") = 7 lattes

→ Pour emballages renforcés, voir intérieur de la couverture.

→ **Housse de protection "Casper", voir page 74.**

Table bar haute

Code	Longueur (L)	Prof.	Pieds	Plateau	Prix en EURO	Coûts	m ³	Kg
24BEA01	160	59	laqué	Teck		1	0,31	45
24BEA02	180	59	laqué	Teck		1	0,34	47
24BEA03	200	59	laqué	Teck		1	0,38	49
24BEA04	220	59	laqué	Teck		1	0,41	54
24BEA07	160	79	laqué	Teck		1	0,40	50
24BEA08	180	79	laqué	Teck		1	0,44	54
24BEA09	200	79	laqué	Teck		1	0,48	59
24BEA10	220	79	laqué	Teck		1	0,52	65

Optionals

Code		Prix en EURO	Coûts	m ³	Kg
02GTA02	 coupe des pieds sur mesure		-	-	-

Table basse

Code	Longueur (L)	Prof.	Haut.	Pieds	Plateau	Prix en EURO	Coûts	m ³	Kg
01BEA50F	80	79	20	laqué	Teck		1	0,19	22
01BEA51F	100	99	20	laqué	Teck		1	0,25	37
01BEA52F	80	79	35	laqué	Teck		1	0,19	24
01BEA53F	100	99	35	laqué	Teck		1	0,25	39

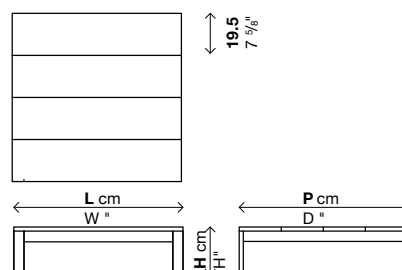
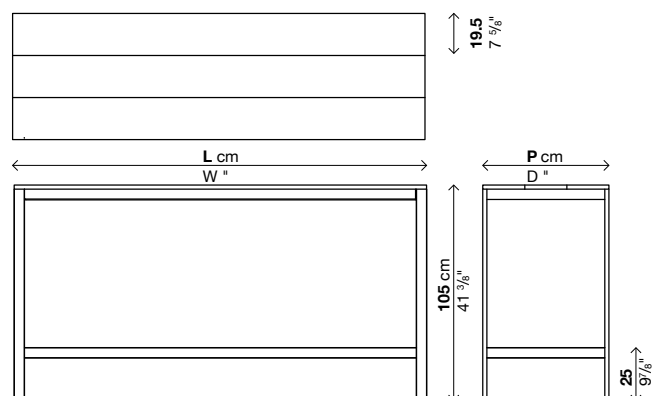

be-Easy slatted

Dimensiones

Mesa

Prof. 79 cm
Prof. 31 1/8"

79

80 cm
31 1/8"

 → Teca

160 cm
63"

 → Teca

180 cm
70 7/8"

 → Teca

200 cm
78 6/8"

 → Teca

220 cm
86 5/8"

 → Teca

Prof. 99 cm
Prof. 39"

99

100 cm
39 3/8"

 → Teca

160 cm
63"

 → Teca

180 cm
70 7/8"

 → Teca

200 cm
78 6/8"

 → Teca

220 cm
86 5/8"

 → Teca

Prof. 139cm
Prof. 54 6/8"

139

140 cm
55 1/8"

 → Teca

Banco

Prof. 40 cm
Prof. 15 6/8"

40

140 cm
55 1/8"

 → Teca

160 cm
63"

 → Teca

180 cm
70 7/8"

 → Teca

200 cm
78 6/8"

 → Teca

Barra

Prof. 59 cm
Prof. 23 2/8"

59

160 cm
63"

 → Teca

180 cm
70 7/8"

 → Teca

200 cm
78 6/8"

 → Teca

220 cm
86 5/8"

 → Teca

Prof. 79 cm
Prof. 31 1/8"

79

160 cm
63"

 → Teca

180 cm
70 7/8"

 → Teca

200 cm
78 6/8"

 → Teca

220 cm
86 5/8"

 → Teca

Sobres esp. 20 mm

Mesa auxiliar

79 80 cm
31 1/8" → Teca

99 100 cm
39 3/8" → Teca

Teca

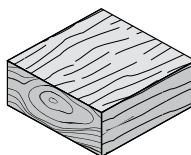

Con el paso del tiempo, la teca no tratada adoptará el típico color plateado que caracteriza a esta madera cuando se utiliza al aire libre. Este proceso estético no influye en la calidad o la resistencia del material.

Para la limpieza normal de la teca se puede utilizar un detergente específico para muebles de madera de exteriores o simplemente un cepillo de cerda blanda con agua.

Para evitar la oxidación superficial del producto nuevo, se puede aplicar **ICADECK** (aceite al agua)

Para eliminar la pátina gris debida a la oxidación y restablecer el color original de la teca, utilizar **CLEANDECK** (detergente antigris). El tratamiento con **CLEANDECK** debe ir seguido de un lavado y de la aplicación de **ICADECK** sobre la superficie seca.

Se desaconseja el uso de hidrolimpiadoras, dado que podrían dañar la superficie y las fibras de la madera. Para eliminar las rayas superficiales se puede utilizar papel de lija o una lijadora manual.

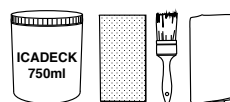

KIT ICADECK

ICADECK + esponja abrasiva + pincel + paño



ICADECK



CLEANDECK

Código		Precios EURO	Packs	Vol. m ³	Kg
02KITOUT01	KIT ICADECK (aceite al agua)		1	0,01	2
02KITOUT02	ICADECK (aceite al agua)		1	0,01	1,5
02KITOUT03	CLEANDECK (detergente antigris)		1	0,01	1,5

be-Easy slatted

Mesa/Banco

Acabado estructura:

Aluminio anodizado

Acabado patas:

Acero barnizado blanco (parecido al Ral 9016)

Acero barnizado "Gris Londres Fenix-NTM@" (parecido al Ral Design0805005)

Acero barnizado negro (parecido al Ral 9004)

Acero barnizado verde oliva (ref. color "Poliuretano verde oliva PO08")

Acabado sobre:

Teca

→ **Profundidad = # listones**

P 40 cm (15 5/8") = 2 listones

P 59 cm (23 2/8") = 3 listones

P 79 cm (31 1/8") = 4 listones

P 99 cm (39") = 5 listones

P 139 cm (54 6/8") = 7 listones

→ *Embalajes reforzados, ver lado interno de la portada.*

→ *Funda de protección "Casper" ver pág. 74.*

Mesa

Código	Longitud (L)	Prof.	Patatas	Sobre	Precios EURO	Packs	Vol. m ³	Kg
01BEA30F	80	79	barnizado	Teca		1	0,19	27
01BEA31F	160	79	barnizado	Teca		1	0,37	42
01BEA32F	180	79	barnizado	Teca		1	0,39	44
01BEA33F	200	79	barnizado	Teca		1	0,45	48
01BEA34F	220	79	barnizado	Teca		1	0,49	52
01BEA37F	100	99	barnizado	Teca		1	0,25	42
01BEA38F	160	99	barnizado	Teca		1	0,45	54
01BEA39F	180	99	barnizado	Teca		1	0,48	56
01BEA40F	200	99	barnizado	Teca		1	0,55	63
01BEA41F	220	99	barnizado	Teca		1	0,59	67
01BEA44F	140	139	barnizado	Teca		1	0,55	67

Banco

Código	Longitud (L)	Prof.	Patatas	Sobre	Precios EURO	Packs	Vol. m ³	Kg
23BEA01	140	40	barnizado	Teca		1	0,18	23
23BEA02	160	40	barnizado	Teca		1	0,20	24
23BEA03	180	40	barnizado	Teca		1	0,23	26
23BEA04	200	40	barnizado	Teca		1	0,25	28

Opcionales

Código		Precios EURO	Packs	Vol. m ³	Kg
02GTA02	 corte pata a medida	-	-	-	-

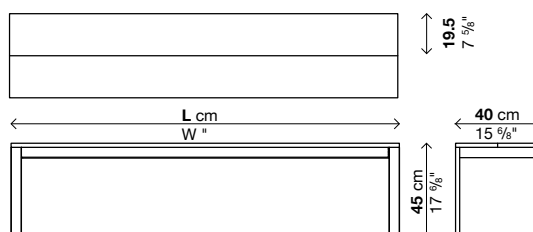
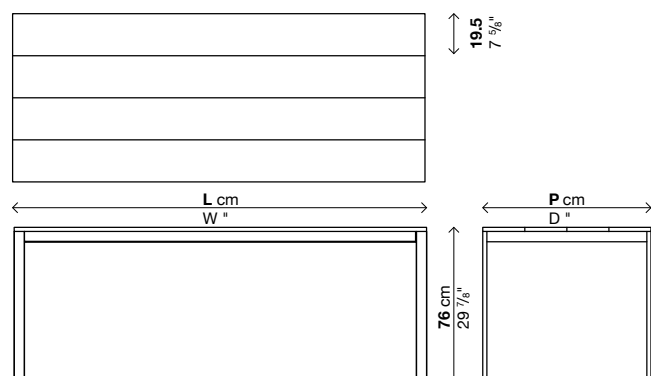

be-Easy slatted

Barra/Mesa auxiliar

Acabado estructura:

Aluminio anodizado

Acabado patas:

Acero barnizado blanco (parecido al Ral 9016)

Acero barnizado "Gris Londres Fenix-NTM®" (parecido al Ral Design0805005)

Acero barnizado negro (parecido al Ral 9004)

Acero barnizado verde oliva (ref. color "Poliuretano verde oliva PO08")

Acabado sobre:

Teca

→ **Profundidad = # listones**

P 40 cm (15⁵/₈") = 2 listones

P 59 cm (23²/₈") = 3 listones

P 79 cm (31¹/₈") = 4 listones

P 99 cm (39") = 5 listones

P 139 cm (54⁶/₈") = 7 listones

→ *Embalajes reforzados, ver lado interno de la portada.*

→ **Funda de protección "Casper" ver pág. 74.**

Barra

Código	Longitud (L)	Prof.	Patatas	Sobre	Precios EURO	Packs	Vol. m ³	Kg
24BEA01	160	59	barnizado	Teca		1	0,31	45
24BEA02	180	59	barnizado	Teca		1	0,34	47
24BEA03	200	59	barnizado	Teca		1	0,38	49
24BEA04	220	59	barnizado	Teca		1	0,41	54
24BEA07	160	79	barnizado	Teca		1	0,40	50
24BEA08	180	79	barnizado	Teca		1	0,44	54
24BEA09	200	79	barnizado	Teca		1	0,48	59
24BEA10	220	79	barnizado	Teca		1	0,52	65

Opcionales

Código		Precios EURO	Packs	Vol. m ³	Kg
02GTA02	 corte pata a medida	-	-	-	-

Mesa auxiliar

Código	Longitud (L)	Prof.	Alt.	Patatas	Sobre	Precios EURO	Packs	Vol. m ³	Kg
01BEA50F	80	79	20	barnizado	Teca		1	0,19	22
01BEA51F	100	99	20	barnizado	Teca		1	0,25	37
01BEA52F	80	79	35	barnizado	Teca		1	0,19	24
01BEA53F	100	99	35	barnizado	Teca		1	0,25	39

