

BRIO

Romano Marcato | 2001



BRIO

Romano Marcato | 2001

BRIO, namely playful, useful and versatile. With its elegant functionality and lightness, this table meets all needs as a top in restaurants, the office or any community space. This additional element is as practical as desks and sofas. With a choice of different fixed or easily adjustable heights, it stands out for its beautiful minimalist design.



BRIO

Romano Marcato | 2001

H40 | Small table with round or square top Ø60 ÷ 70 ÷ 80 | 60 ÷ 70 ÷ 80

Table available in several heights or height adjustable with round or square top in several finishes and dimensions. Base covered by a stainless steel sheet "linen fabric" pattern and mat chromed column or entirely powder coated black or white.

TEST EN 1730:2000 6.3 - EN 15372:2008 - L3
TEST EN 1730:2000 6.7 - UNI 10976/2002 - L5



40
15³/₄"

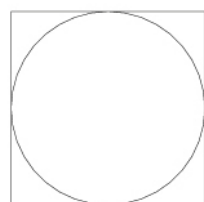

60
23¹/₂"

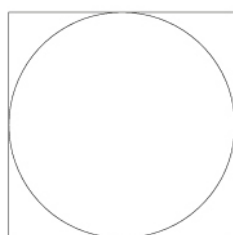

70
27¹/₂"

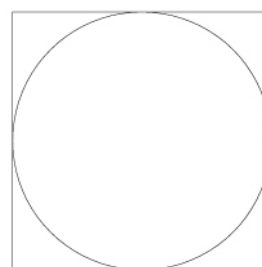

80
31¹/₂"

BRIO

Romano Marcato | 2001

H52÷70 | Height-adjustable table with round or square top Ø60 ÷ 70 | 60 ÷ 70

Table available in several heights or height adjustable with round or square top in several finishes and dimensions. Base covered by a stainless steel sheet "linen fabric" pattern and mat chromed column or entirely powder coated black or white.

TEST EN 1730:2000 6.3 - EN 15372:2008 - L3
TEST EN 1730:2000 6.7 - UNI 10976/2002 - L5

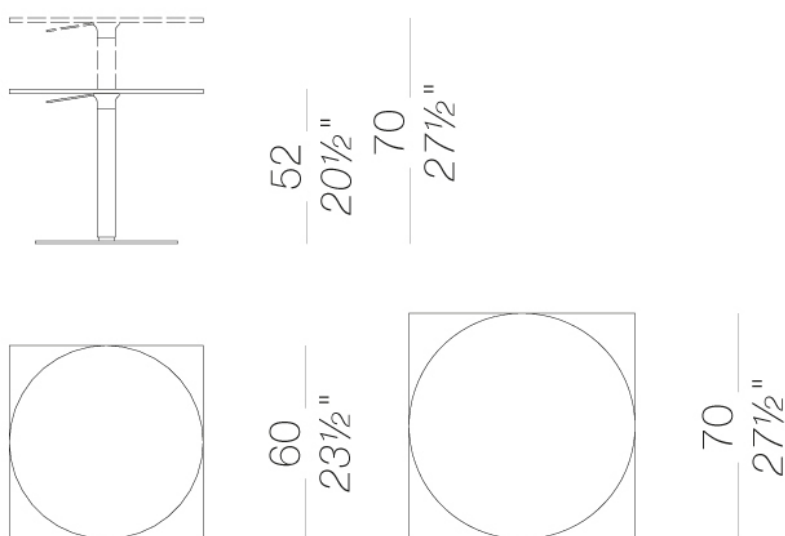

BRIO

Romano Marcato | 2001

H72 | Table with round or square top for bars or restaurants $\varnothing 60 \div 70 \div 80$ | $60 \div 70 \div 80$

Table available in several heights or height adjustable with round or square top in several finishes and dimensions. Base covered by a stainless steel sheet "linen fabric" pattern and mat chromed column or entirely powder coated black or white.

TEST EN 1730:2000 6.3 - EN 15372:2008 - L3
TEST EN 1730:2000 6.7 - UNI 10976/2002 - L5

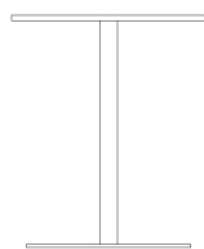

72
28 1/4"

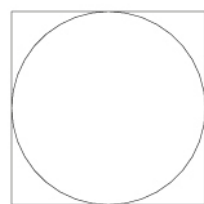

60
23 1/2"

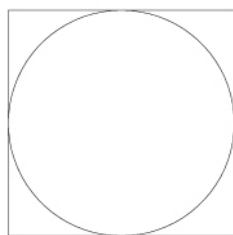

70
27 1/2"

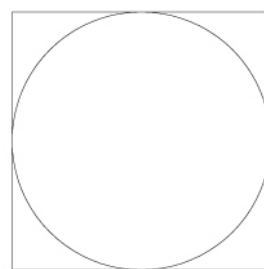

80
31 1/2"

BRIO

Romano Marcato | 2001

H72÷102 | Height-adjustable bar table with round or square top Ø60 ÷ 70 | 60 ÷ 70

Table available in several heights or height adjustable with round or square top in several finishes and dimensions. Base covered by a stainless steel sheet "linen fabric" pattern and mat chromed column or entirely powder coated black or white.

TEST EN 1730:2000 6.3 - EN 15372:2008 - L3
TEST EN 1730:2000 6.7 - UNI 10976/2002 - L5

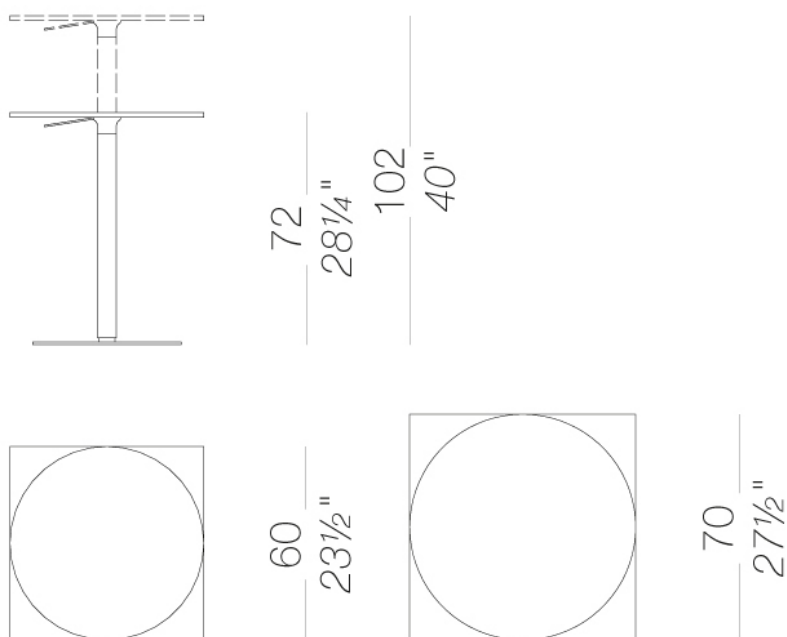

BRIO

Romano Marcato | 2001

H110 | High table for restaurants with round or square top $\varnothing 60 \div 70 \div 80$ | $60 \div 70 \div 80$

Table available in several heights or height adjustable with round or square top in several finishes and dimensions. Base covered by a stainless steel sheet "linen fabric" pattern and mat chromed column or entirely powder coated black or white.

TEST EN 1730:2000 6.3 - EN 15372:2008 - L3
TEST EN 1730:2000 6.7 - UNI 10976/2002 - L5

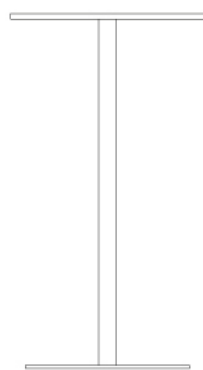

110
43 1/4"

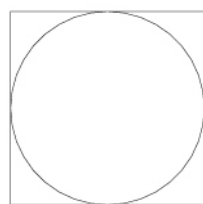

60
23 1/2"

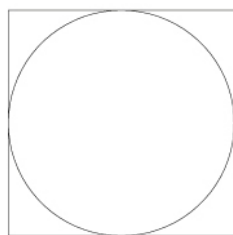

70
27 1/2"

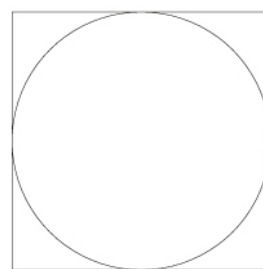

80
31 1/2"

BRIO

Romano Marcato | 2001

base



powder coating
black
1 Colors

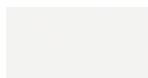

powder coating
white
1 Colors



metal
stainless steel
1 Colors

leg



powder coating
black
1 Colors

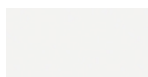

powder coating
white
1 Colors



metal
mat chromed
1 Colors

top

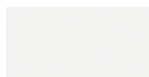

laminate
406 abet 9/10
1 Colors

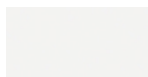

HPL 10 mm
HPL H406
1 Colors

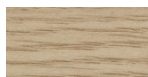

HPL 10 mm
HPL blanched oak
1 Colors



HPL 10 mm
HPL fenix
2 Colors



wood
blanched oak
1 Colors

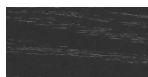

wood
black open pore
1 Colors



wood
oak dark walnut
1 Colors

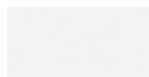

lacquered
white lacquered
1 Colors

consult the portfolio for the range of colors, fabrics, eco-leather, soft-leather.

use and maintenance instructions

Clean all parts in wood, leather, fabric and metal with a damp cloth or a diluted neutral cleaner. Do not use cleaners with alcohol, bleach, solvent or abrasive products. Any liquid spilt on the product must be wiped up immediately. When lifting or moving the product, hold it on the structure and not under the seat. The product should not be subjected to unbalanced weights, as it is designed for a proper rest on the foothold (on four legs or on the base). Our company relieves from any responsibility in case of damage caused to fragile floors. Avoid any improper use of the product: do not step on the product, on the footrest or on the armrests. Avoid any movements that could compromise the proper functionality of the product or the safety of the users. Wood and leather, being natural materials, could be easily damaged. Small impurities or imperfections are within quality standard range. Do not expose the product to weather conditions or atmospheric agents, nor to heat sources over 40°C. Also products for outdoor use could be afflicted by atmospheric agents. The product could undergo possible exterior changes due to particular exposure to heat, humidity and saltiness. An appropriate and frequent maintenance and cleaning of the product enhances its durability. The product could change colour and shade, if exposed to direct sunlight. Maintenance has to be carried out by experienced staff. Dispose of the package only after assembling the product, in order to avoid the loss of ironmongery and components. Once the product has been dismantled, the product itself or its components must be given to the public garbage disposal system, according to the legislation in force.