



Console made entirely of solid wood in glued lists, with straight sides, characterized by a dovetail joint between the top and the legs. Equipped with a metal bar to be used as footrest.

**STANDARD VERSION: IRON FOOTREST LACQUERED IRONDUST COLOUR (B2)**

CODE	SIZE	FOOTREST	A1	A2	A4
FRAME-BAR1	W.210 x D.35 x H.108	B2	■	■	■
		B3	■	■	■
FRAME-BAR2	W.230 x D.35 x H.108	B2	■	■	■
		B3	■	■	■
FRAME-BAR3	W.250 x D.35 x H.108	B2	■	■	■
		B3	■	■	■

**AVAILABLE FINISHES:**

**A1:** walnut without knots, walnut with knots

**A2:** oak without knots, oak with knots, cherry, maple

**A4:** oak without knots pigmented: total black

oak with knots pigmented: total black

**B2:** lacquered iron: iron dust, RAL (only selected colours)

**B3:** lacquered iron matt brushed effect: aged bronze, stainless steel, titanium

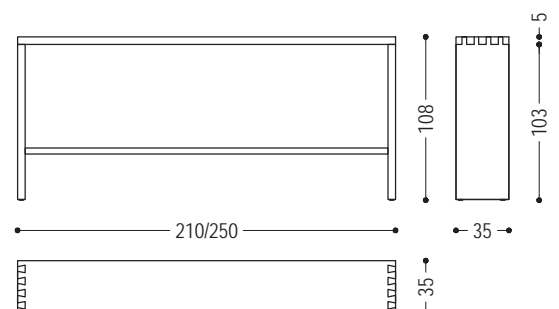

# FRAME BAR | AVAILABLE FINISHES

---

## WOOD

A1

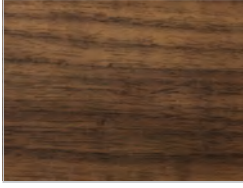

walnut without knots



walnut with knots

A2

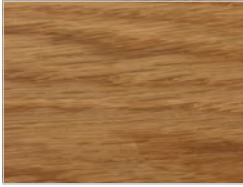

oak without knots



oak with knots



cherry



maple

A4

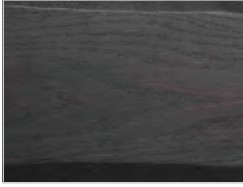









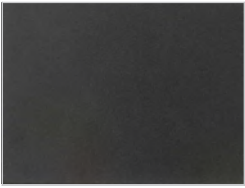

oak without knots pigmented:  
total black

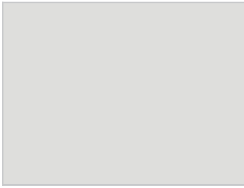

oak with knots pigmented:  
total black

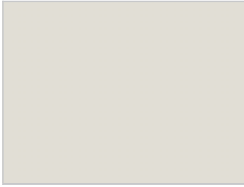
# FRAME BAR | AVAILABLE FINISHES

## IRON

B2					
					
					
B3	