

ESTER

S. Bigi

2013



porada

Sedia in massello di noce canaletta o frassino e rivestimento nei tessuti della collezione.

Chair in canaletta walnut or ash and seat covered in the fabrics of the collection.

Stuhl mit Gestell aus massivem Nussbaum Canaletta oder Esche und Bezug in den Stoffen der Kollektion.

Chaise en noyer canaletta ou frêne massif et siège revêtu dans les tissus de la collection.

Silla en nogal canaletta o fresno macizo y asiento revestido en las telas de la colección.

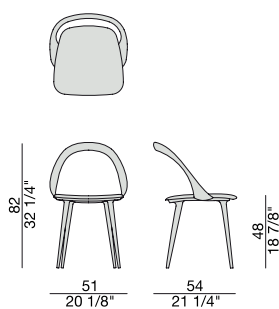

ESTER BRACCIOLI

S. Bigi

2013

Sedia con braccioli con struttura in massello di noce canaletta o frassino e rivestimento nei tessuti della collezione.

Chair with arms with frame in canaletta walnut or ash and seat covered in the fabrics of the collection.

Stuhl mit Lehnen mit Gestell aus massivem Nussbaum Canaletta oder Esche und Bezug in den Stoffen der Kollektion.

Chaise avec accoudoirs avec structure en noyer canaletta ou frêne massif et siège revêtu dans les tissus de la collection.

Silla con brazos con estructura en nogal canaletta o fresno macizo y asiento revestido en las telas de la colección.

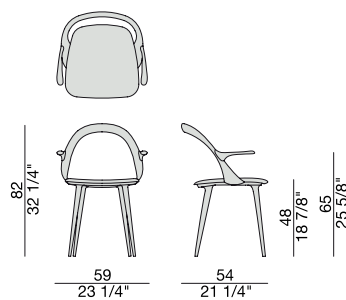

ESSENZE | *Essences*



Noce Canaletta
Canaletta Walnut

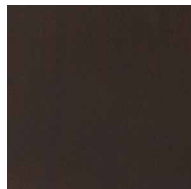

Noce Canaletta
Canaletta Walnut
tinto/stained moka



Noce Canaletta
Canaletta Walnut
tinto/stained wengé



Frassino Naturale
Natural Ash



Frassino
Ash
tinto/stained moka

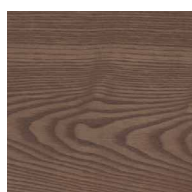

Frassino
Ash
*tinto noce canaletta
canaletta walnut stained*

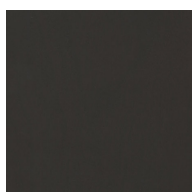

Frassino
Ash
tinto/stained wengé



Frassino
Ash
tinto/stained canapa

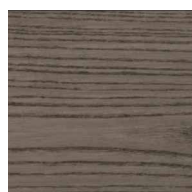

Frassino
Ash
tinto/stained caffè

LACCATO OPACO PORO APERTO | *Matt lacquered open pore*

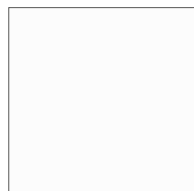

Bianco
White
(RAL 9016)

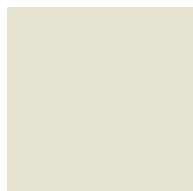

Avorio
Ivory
(RAL 1013)

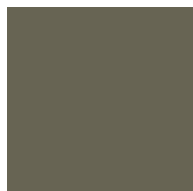

Argilla
Mud
(RAL 7006)



Piombo
Lead
(NCS S5005G20Y)



Cioccolato
Chocolate
(RAL 8019)

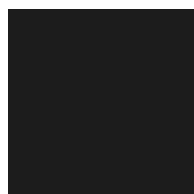

Nero
Black
(RAL 9005)



Granata
Garnet red
(NCS S4050Y90R)



Pistacchio
Pistachio green
(PANTONE 5825)



Avio
Aviation blue
(PANTONE 5415)

PELLE | *Leather*

Categoria LUX



Nabuk

Categoria PLUS



Pelle PLUS

Categoria PELLE



Pelle

Categoria EXTRA

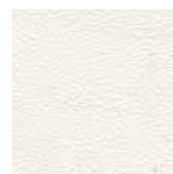

Pelle EXTRA

RIVESTIMENTO | *Cover*

Categoria A



Hallingdal 65

Categoria B



Rabat



Milord

Categoria C



Fashion



Moran



Thalys

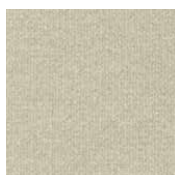

Velvet



Wool



Flax



Armam



Ikat



Loom

Categoria D



Astra

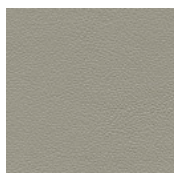

Ecopelle



Range



Tress

Categoria E

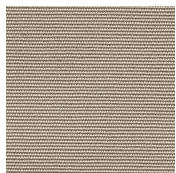

Cotone



Dorian

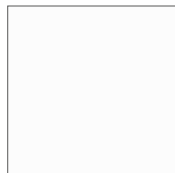

In Bianco/Calico

Categoria COM

Disponibile con tessuto fornito dal cliente.

Available with fabric supplied by the customer.

Verfügbar mit Kundenstoff.

Disponible avec tissu du client.

Disponibile con tela suministrada por el cliente.