

Grace / Folding square counter table
80x80x74
Design / Samuel Wilkinson

Originating from a collaboration with the designer Samuel Wilkinson, Grace is a collection with an essential, vintage, timeless style, well-suited both outdoors and indoors to create a distinctive retro atmosphere. The Grace collection is made up of a chair, armchair and table, together with a stool and counter table, all made entirely of aluminium. The minimalist, design makes for a sophisticated, elegant collection.



Description

Code: **285+286**
Typology: **Collapsible**
Collection: **Grace**

Static Load: 100 Kg
Folding: Yes
Shape: Square

Technical Info

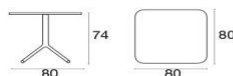

Width: **80 cm**
Depth: **80 cm**
Height: **74 cm**
Weight: **12.5 Kg**
Static Load: **100 Kg**

Packaging

Packages: **2**
Pieces for pack: **1**
Dimensions: **57x57x33 cm - 90x13x90 cm**
Volume: **0.212 mc**
Polyethylene bag and cardboard box

Grace / Folding square counter table
80x80x74
Design / Samuel Wilkinson

Colors



17
Military Green



23
Matt White



24
Black



26
Maple Red



37
Grey/Green



50
Scarlet Red



73
Cement



75
Dark Green

Grace / Folding square counter table
80x80x74
Design / Samuel Wilkinson

Materials

Aluminium

Aluminium alloys, particularly suitable for cold-working and for die-casting, appropriately treated to withstand the elements and powder coated.

Maintenance: To keep the product in good condition for a long time, we recommend cleaning it regularly; more often in very damp locations with a marine climate. It is recommended to clean the surfaces using a soft cloth with water or mild detergents. Prolonged and continuous exposure to intense UV radiation or very low temperatures can affect the initial characteristics of the coloured coating, which is made from polyester. We recommend cleaning and storing the products in sheltered places during prolonged periods of non-use and during the winter.