

Tables—Low tables

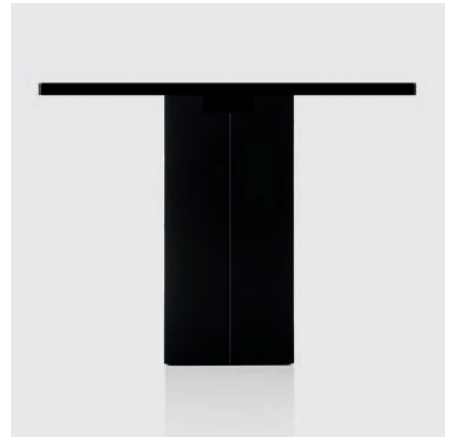

Holo

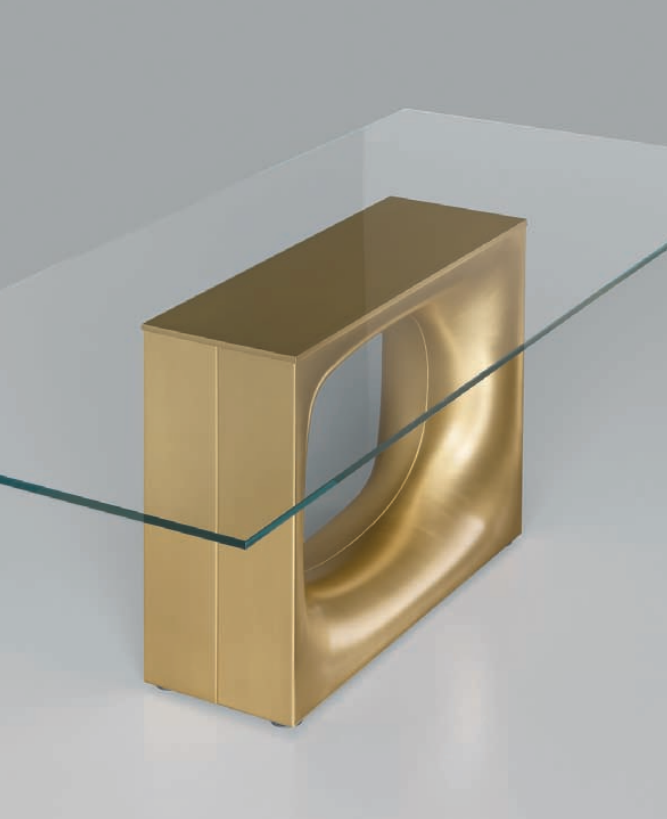

Tables—Low tables

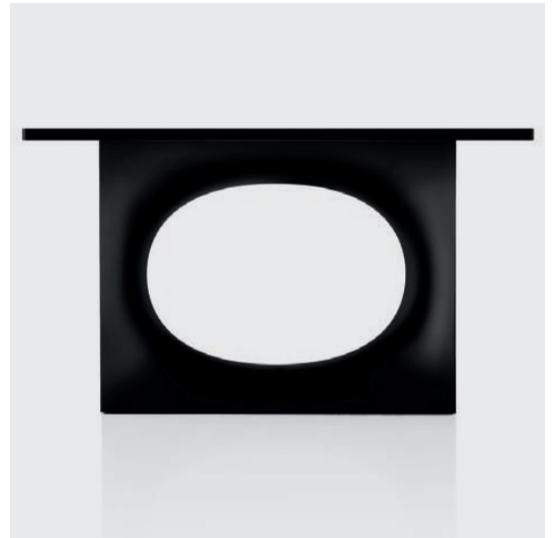

Holo

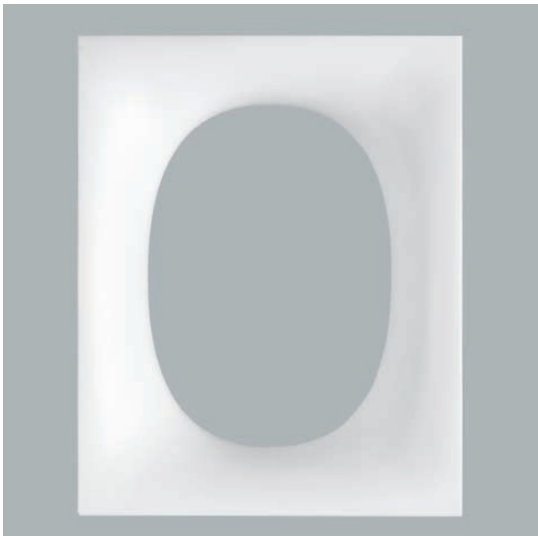
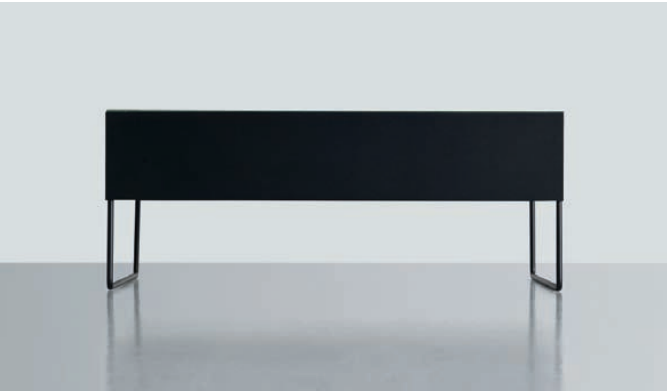
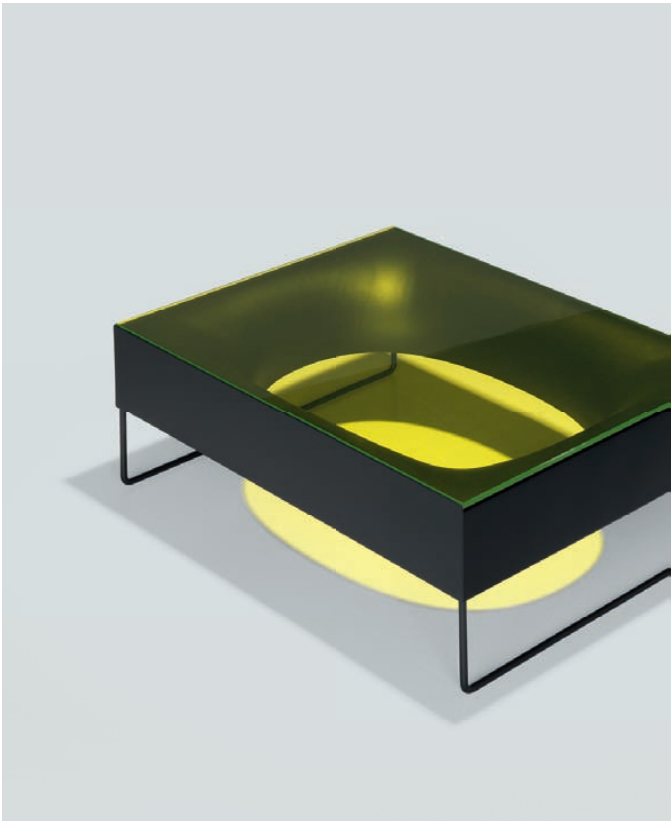

Tables—Low tables



Type

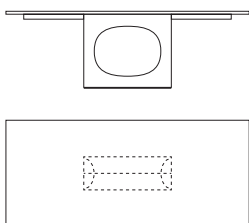

Table with central base  
**L 220 P 110 H 75 cm**  
**W 86<sup>5</sup>/<sub>8</sub>" D 43<sup>2</sup>/<sub>8</sub>" H 29<sup>4</sup>/<sub>8</sub>"**

**L 250 P 110 H 75 cm**  
**W 98<sup>3</sup>/<sub>8</sub>" D 43<sup>2</sup>/<sub>8</sub>" H 29<sup>4</sup>/<sub>8</sub>"**

**L 280 P 110 H 75 cm**  
**W 110<sup>2</sup>/<sub>8</sub>" D 43<sup>2</sup>/<sub>8</sub>" H 29<sup>4</sup>/<sub>8</sub>"**

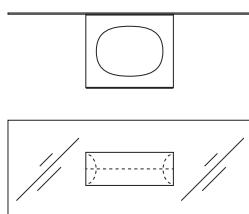
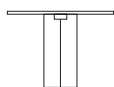

Table with central base - glass top  
**L 220 P 100 H 75 cm**  
**W 86<sup>5</sup>/<sub>8</sub>" D 39<sup>3</sup>/<sub>8</sub>" H 29<sup>4</sup>/<sub>8</sub>"**

**L 250 P 100 H 75 cm**  
**W 98<sup>3</sup>/<sub>8</sub>" D 39<sup>3</sup>/<sub>8</sub>" H 29<sup>4</sup>/<sub>8</sub>"**

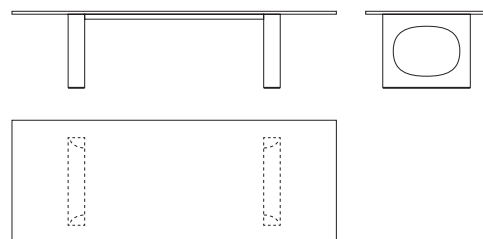
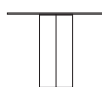

Table with double base  
**L 320 P 120 H 75 cm**  
**W 126" D 47<sup>2</sup>/<sub>8</sub>" H 29<sup>4</sup>/<sub>8</sub>"**

**L 360 P 135 H 75 cm**  
**W 141<sup>6</sup>/<sub>8</sub>" D 53<sup>1</sup>/<sub>8</sub>" H 29<sup>4</sup>/<sub>8</sub>"**

# Holo

## Kensaku Oshiro

**IT** Dall'incontro fra la tecnologia di Kristalia e la creatività di Kensaku Oshiro nasce Holo: un tavolo caratterizzato dall'inedita base con un foro ovale, dal contorno morbidamente plasmato, realizzata in lamiera di metallo con un processo che prevede numerosi passaggi di stampaggio e piegatura. Su questa originale e stabile base, proposta con varie finiture, è appoggiato un piano in laminato, vetro oppure in legno massello. Tre diverse possibilità per un elemento d'arredo dalla personalità davvero unica.

La collezione Holo arricchisce ulteriormente la propria gamma e presenta il nuovo tavolino e la consolle, completamente ideale per un unico e raffinato spazio living.

**EN** The combination of Kristalia's technology with Kensaku Oshiro's creativity has led to Holo: a table featuring an original base and an oval hole, with a softly moulded shape in sheet metal, made using a process that involves many moulding and bending phases. This original and stable base, available in various finishes, supports a laminate, glass or solid wood top. Three options are available for this furnishing object with a truly unique personality. The Holo collection further enhances the range and includes a new

**occasional table and console table, the perfect finishing touch for a unique and refined living space.**

**DE** Aus dem Treffen zwischen der Technologie Kristalia und der Kreativität von Kensaku Oshiro entsteht Holo: Ein Tisch, der sich durch sein ungewöhnliches Untergestell mit einem ovalen Loch und weich modellierten Linien auszeichnet, das mit einem besonderen Prozess mit zahlreichen Spritzguss- und Biegedurchgängen aus Metallblech hergestellt wird. Auf diesem originellen, stabilen und in mehrere Ausführungen angebotenen Untergestell ruht eine Platte aus Laminat, Glas oder aus massivem Holz. Drei verschiedene Möglichkeiten für ein Einrichtungselement mit wirklich einzigartiger Persönlichkeit.

Die Kollektion Holo erweitert ihr Produktangebot und präsentiert den neuen Beistelltisch und die Tischkonsole, das ideale Einrichtungselement für einen einzigartigen und raffinierten Wohnraum.

**ES** Del encuentro entre la tecnología de Kristalia y la creatividad de Kensaku Oshiro nace Holo: una mesa caracterizada por una base inédita con un orificio oval, de contorno suavemente plasmado, realizada en chapa de metal con un

proceso que abarca numerosas fases de moldeado y pliegue. Sobre esta base estable y original, propuesta en varios acabados, apoya un sobre de laminado, vidrio o madera maciza. Tres posibilidades distintas en un elemento decorativo con una personalidad realmente única. La colección Holo enriquece su gama presentando una nueva mesita y una consola, complementos ideales en una exclusiva y refinada sala de estar.

**FR** L'alliance technologie Kristalia et créativité Kensaku Oshiro a engendré Holo: une table se caractérisant par son piètement présentant une ouverture ovale au souple contour modelé, réalisé en tôle métallique grâce à un processus prévoyant de nombreuses étapes de moulage et de pliage. C'est sur ce piètement original et stable, proposé en différentes finitions, que repose un mince plateau disponible en stratifié, en verre ou bien en bois massif: trois solutions proposées pour un article de décoration à la personnalité tout à fait unique.

La collection Holo enrichit ultérieurement sa propre gamme avec deux nouvelles arrivées: une table basse et une consolle permettant ainsi de compléter l'espace séjour de façon authentique et raffinée.

### Type



Occasional table  
L 90 P 71 H 36 cm  
W 35<sup>3/8</sup>" D 28" H 14<sup>1/8</sup>"

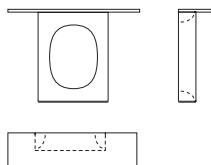
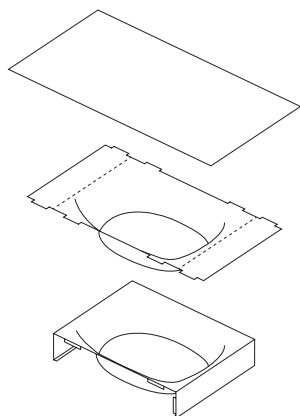

Consolle  
L 140 P 35 H 94 cm  
W 55<sup>1/8</sup>" D 13<sup>6/8</sup>" H 37"

### Steel base



### Brass base



### Fenix-NTM® top



### Wood top



### Transparent glass top



⚠ Not all finishes are available in sizes listed. Refer to current price list.