



JEAN BOTTE

C. Ballabio

2013

Tavolo da pranzo con base in metallo e piano in legno massello noce canaletta, marmo (spessore mm. 20) o cristallo (spessore mm.15).

Dining-table with metal base and solid canaletta wood, marble (thickness mm. 20) or glass (thickness mm. 15) top.

Ess-Tisch mit Metallgestell und Fassungplatte aus massivem Nussbaum Canaletta, Glas, Marmor (Stärke mm. 20) oder Glas (Stärke mm. 15).

Table à manger avec piétement en métal et plateau en noyer canaletta massif, marbre (épaisseur mm. 20), ou verre (épaisseur mm. 15).

Mesa de comedor con base en metal y tapa en nogal canaletta macizo, mármol (espesor mm. 20) o cristal (espesor mm. 15).

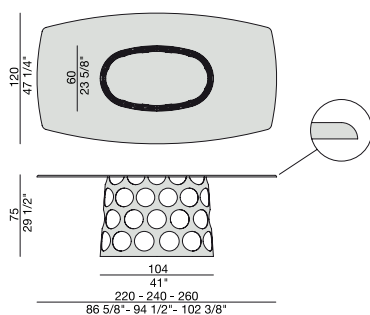

JEAN C

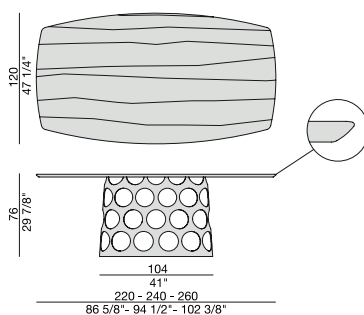

JEAN L

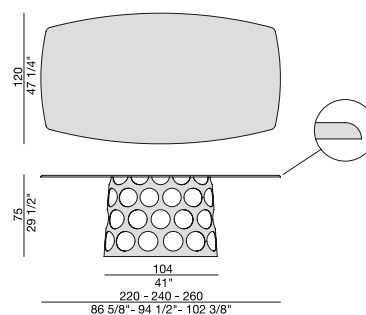

JEAN M

METALLO | *Metal*

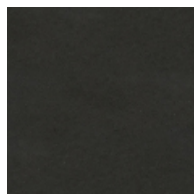

Nero opaco
Matt black



Bianco opaco
Matt white

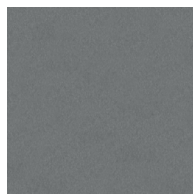

Grigio Peltro
Grey Pewter

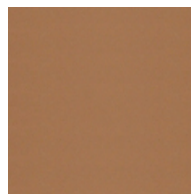

Copper
Copper color



Bronzoro

PIANO | *Top*

Essenze | *Essences*



Noce Canaletta
Canaletta Walnut

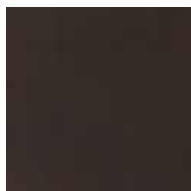

Noce Canaletta
Canaletta Walnut
tinto/stained moka



Noce Canaletta
Canaletta Walnut
tinto/stained wengé

LACCATO OPACO PORO CHIUSO | *Matt lacquered closed pore*

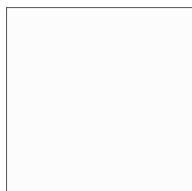

Bianco
White
(RAL 9016)

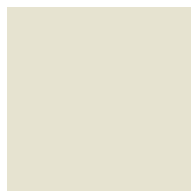

Avorio
Ivory
(RAL 1013)



Argilla
Mud
(RAL 7006)



Piombo
Lead
(NCS S5005G20Y)



Cioccolato
Chocolate
(RAL 8019)

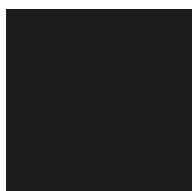

Nero
Black
(RAL 9005)



Granata
Garnet red
(NCS S4050Y90R)



Pistacchio
Pistachio green
(PANTONE 5825)



Avio
Aviation blue
(PANTONE 5415)

Marmo | *Marble*

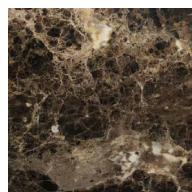

Emperador Dark



Calacatta oro



Sahara Noir

CRISTALLO | *Glass*

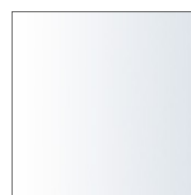

Bianco
White



JEAN TONDO

C. Ballabio

2013

Tavolo da pranzo con base in metallo e piano in legno massello noce canaletta, marmo (spessore mm. 20) o cristallo (spessore mm.15).

Dining-table with metal base and solid canaletta wood, marble (thickness mm. 20) or glass (thickness mm. 15) top.

Ess-Tisch mit Metallgestell und Fassplatte aus massivem Nussbaum Canaletta, Glas, Marmor (Stärke mm. 20) oder Glas (Stärke mm. 15).

Table à manger avec piétement en métal et plateau en noyer canaletta massif, marbre (épaisseur mm. 20), ou verre (épaisseur mm. 15).

Mesa de comedor con base en metal y tapa en nogal canaletta macizo, mármol (espesor mm. 20) o cristal (espesor mm. 15).

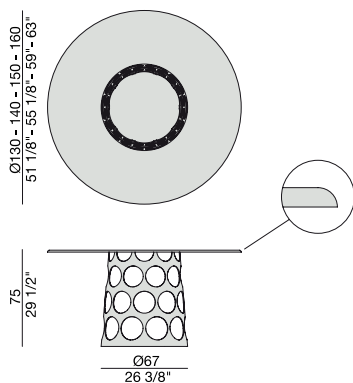

JEAN C

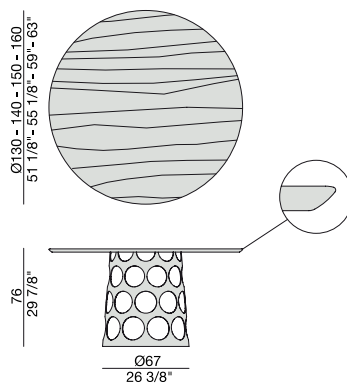

JEAN L

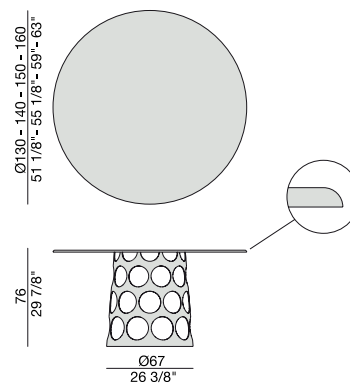

JEAN M

METALLO | *Metal*

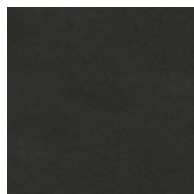

Nero opaco
Matt black



Bianco opaco
Matt white



Grigio Peltro
Grey Pewter

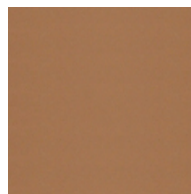

Copper
Copper color



Bronzoro

PIANO | *Top*

Essenze | *Essences*



Noce Canaletta
Canaletta Walnut

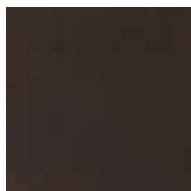

Noce Canaletta
Canaletta Walnut
tinto/stained moka



Noce Canaletta
Canaletta Walnut
tinto/stained wengé

LACCATO OPACO PORO CHIUSO | *Matt lacquered closed pore*

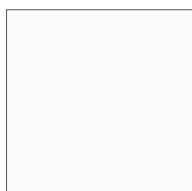

Bianco
White
(RAL 9016)

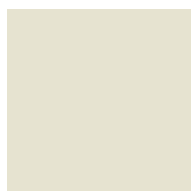

Avorio
Ivory
(RAL 1013)



Argilla
Mud
(RAL 7006)



Piombo
Lead
(NCS S5005G20Y)



Cioccolato
Chocolate
(RAL 8019)

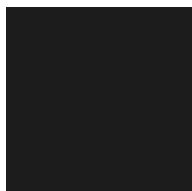

Nero
Black
(RAL 9005)



Granata
Garnet red
(NCS S4050Y90R)



Pistacchio
Pistachio green
(PANTONE 5825)



Avio
Aviation blue
(PANTONE 5415)

Marmo | *Marble*

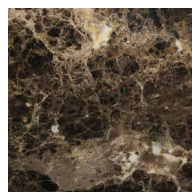

Emperador Dark



Calacatta oro



Sahara Noir

CRISTALLO | *Glass*

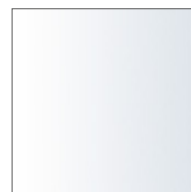

Bianco
White