

design — Wolfgang C.R. Mezger



Jolly, 751/AI-GAS
sgabello \ stool

La famiglia di sgabelli Jolly si contraddistingue per la scocca rigida ed ergonomica dello schienale, in tessuto o pelle, dalla curvatura tridimensionale. Lo sgabello ha gambe in rovere o base centrale regolabile in metallo. Quest'ultimo è proposto, inoltre, con schienale esterno rivestito in rovere.

The Jolly stools' collection is characterized by a rigid, ergonomic backrest shell, made of fabric or leather as per collection, with a three-dimensional curvature. The stools have oak legs or a central adjustable metal base. These are also proposed with an external oak backrest.

Informazioni tecniche \ *Technical information*

Descrizione tecnica \ *Technical description*

Sgabello imbottito con base centrale girevole in metallo tonda o quadrata con regolazione a gas, seduta e schienale imbottiti in poliuretano espanso ignifugo. Schienale esterno rivestito in legno rovere. Finiture e rivestimenti di collezione.

Upholstered stool with round or square metal swivel central base with gas height adjustment system, upholstered seat and backrest with fire retardant polyurethane foam padding. External backrest in oak. Finishes and coverings as per collection.

Dimensioni \ *Dimensions*

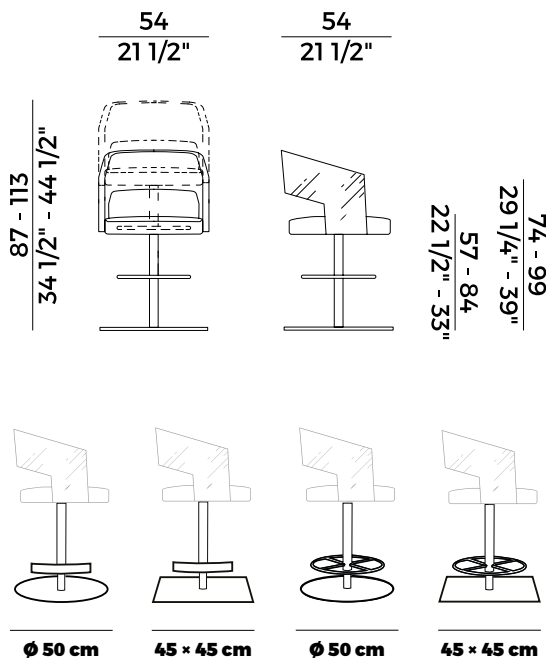

Consumi stoffe \ *Fabric and leather requirements*

FABRIC / LEATHER REQUIREMENTS

	x1	x2
H 140	ml 0,80	ml 1,60
LEATHER	m ² 1,40	

FABRIC / LEATHER REQUIREMENTS

	x1	x2
H 140	yd 0.90	yd 1.75
LEATHER	ft ² 16	



PACKAGING

1 x crt = m³ 0.40
gross weight - Kg 29.5

Finiture \ *Finishes*

Finiture struttura \

Frame finishes

Metallo \ *Metal*

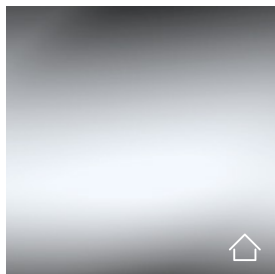

Cromato \
Chrome

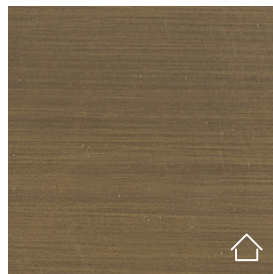

Ottone brunito \
Bronzed Brass

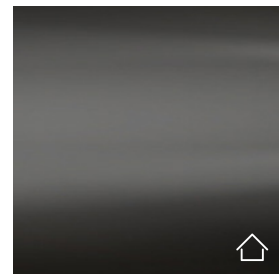

Cromo nero \
Black Chrome

Finiture schienale esterno \

External backrest finishes

Rovere \ *Oak*



UH
Tinto Anilina Beige \
Beige Aniline Stained



UC
Tinto Biscotto \
Biscuit Stained



TD
Tinto Moka \
Moka Stained

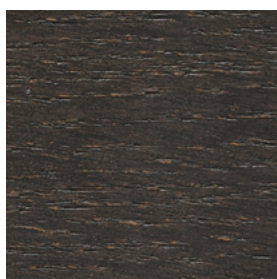

TA
Tinto Grigio Plumbeo \
Dark Grey Stained

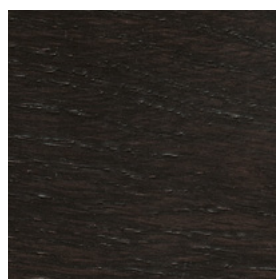

TY
Tinto Wengé \
Wengé Stained



RQ
Tinto Carbone \
Carbon Stained

Rivestimenti \

Coverings

Tessuto, ecopelle, pelle \ *Fabric, eco-leather, leather*

Collezione Jolly \ *Jolly collection*

Sgabelli imbottiti disponibili nelle versioni: sgabello con base a quattro gambe in massello di rovere, seduta e schienale imbottiti in poliuretano espanso ignifugo; sgabello con base centrale girevole in metallo tonda o quadrata con regolazione a gas, seduta e schienale imbottiti in poliuretano espanso ignifugo, disponibile con schienale esterno rivestito in legno rovere. Finiture e rivestimenti di collezione.

Upholstered stools available in the following versions: stool with four legs in solid oak, upholstered seat and backrest with fire retardant polyurethane foam padding; stool with round or square metal swivel central base with gas height adjustment system, upholstered seat and backrest with fire retardant polyurethane foam padding; available with external backrest in oak. Finishes and coverings as per collection.

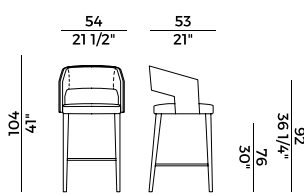

751/AIIW
sgabello alto \ *barstool*

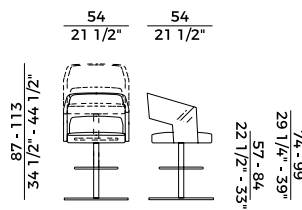

751/AI-GAS
sgabello \ *stool*

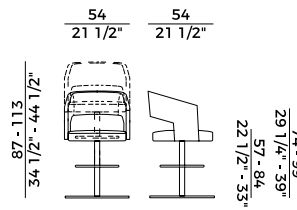

751/AII-GAS
sgabello \ *stool*

design — Wolfgang C.R. Mezger



Jolly, 751/AII-GAS
sgabello \ stool

La famiglia di sgabelli Jolly si contraddistingue per la scocca rigida ed ergonomica dello schienale, in tessuto o pelle, dalla curvatura tridimensionale. Lo sgabello ha gambe in rovere o base centrale regolabile in metallo. Quest'ultimo è proposto, inoltre, con schienale esterno rivestito in rovere.

The Jolly stools' collection is characterized by a rigid, ergonomic backrest shell, made of fabric or leather as per collection, with a three-dimensional curvature. The stools have oak legs or a central adjustable metal base. These are also proposed with an external oak backrest.

Informazioni tecniche \ *Technical information*

Descrizione tecnica \ *Technical description*

Sgabello imbottito con base centrale girevole in metallo tonda o quadrata con regolazione a gas, seduta e schienale imbottiti in poliuretano espanso ignifugo. Finiture e rivestimenti di collezione.

Upholstered stool with round or square metal swivel central base with gas height adjustment system, upholstered seat and backrest with fire retardant polyurethane foam padding. Finishes and coverings as per collection.

Dimensioni \ *Dimensions*

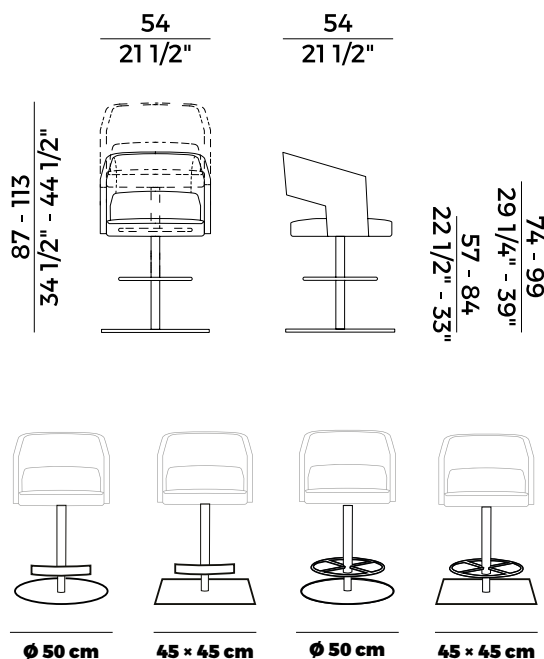

Consumi stoffe \ *Fabric and leather requirements*

FABRIC / LEATHER REQUIREMENTS

	x1	x2
H 140	ml 1,60	ml 3,20
LEATHER	m ² 2,70	

FABRIC / LEATHER REQUIREMENTS

	x1	x2
H 140	yd 1.70	yd 3.50
LEATHER	ft ² 28	



PACKAGING

1 x crt = m³ 0.40
 gross weight - Kg 29.5

Finiture \ *Finishes*

Finiture struttura \

Frame finishes

Metallo \ *Metal*

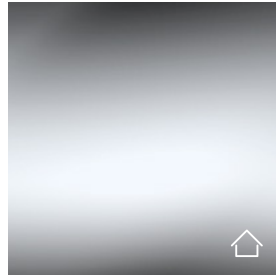

Cromato \
Chrome

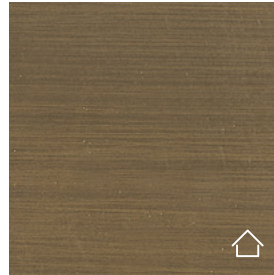

Ottone brunito \
Bronzed Brass

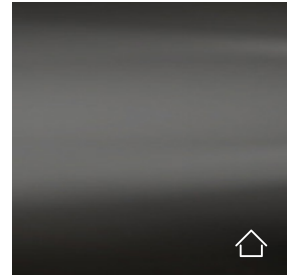

Cromo nero \
Black Chrome

Rivestimenti \

Coverings

Tessuto, ecopelle, pelle \ *Fabric, eco-leather, leather*

Collezione Jolly \
Jolly collection

Sgabelli imbottiti disponibili nelle versioni: sgabello con base a quattro gambe in massello di rovere, seduta e schienale imbottiti in poliuretano espanso ignifugo; sgabello con base centrale girevole in metallo tonda o quadrata con regolazione a gas, seduta e schienale imbottiti in poliuretano espanso ignifugo, disponibile con schienale esterno rivestito in legno rovere. Finiture e rivestimenti di collezione.

Upholstered stools available in the following versions: stool with four legs in solid oak, upholstered seat and backrest with fire retardant polyurethane foam padding; stool with round or square metal swivel central base with gas height adjustment system, upholstered seat and backrest with fire retardant polyurethane foam padding; available with external backrest in oak. Finishes and coverings as per collection.

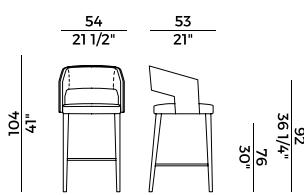

751/AIIW
sgabello alto \ barstool

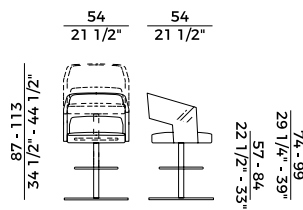

751/AI-GAS
sgabello \ stool

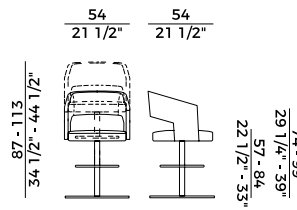

751/AII-GAS
sgabello \ stool