



Letto con struttura realizzata in legno massello abbinata ad una testata imbottita dalle linee morbide ed arrotondate, rivestita in pelle o tessuto sfoderabile. Giroletto stondato.

VERSIONE STANDARD: RETE REGOLABILE; A RICHIESTA RETE FISSA, STESSO PREZZO (chiedere specifiche all'Ufficio Commerciale)

MY BED DOUBLE				
COD.	MISURE	PELLE TESSUTO	A1	A2
MY BED DOUBLE	ingombro totale: L 172 x P 220 x H 95 interno giroletto: L 162 x P 202 materasso consigliato: L 160 x P 200	D1	■	■
		D2	■	■
		D3	■	■
		D4	■	■
		D6	■	■
		D1	■	■
	ingombro totale: L 182 x P 220 x H 95 interno giroletto: L 172 x P 202 materasso consigliato: L 170 x P 200	D2	■	■
		D3	■	■
		D4	■	■
		D6	■	■
		D1	■	■
		D2	■	■
ingombro totale: L 192 x P 220 x H 95 interno giroletto: L 182 x P 202 materasso consigliato: L 180 x P 200	D3	■	■	
	D4	■	■	
	D6	■	■	
	D1	■	■	
	D2	■	■	
	D3	■	■	
ingombro totale: L 212 x P 220 x H 95 interno giroletto: L 202 x P 202 materasso consigliato: L 200 x P 200	D4	■	■	
	D6	■	■	

FINITURE DISPONIBILI:

A1: noce senza nodi, noce con nodi

A2: rovere senza nodi, rovere con nodi, ciliegio, acero

D1: tessuto: canvas, divina melange 2, hallingdal 65, velluto harald

D2: tessuto: maple

D3: pelle: camoscio, cristal

D4: pelle: nabuk, utah

D6: pelle cliente, tessuto cliente

MY BED

VERSIONE STANDARD: RETE REGOLABILE; A RICHIESTA RETE FISSA, STESSO PREZZO (chiedere specifiche all'Ufficio Commerciale)

MY BED				
COD.	MISURE	PELLE TESSUTO	A1	A2
MY BED FRENCH	ingombro totale: L 152 x P 220 x H 95 interno giroletto: L 142 x P 202 materasso consigliato: L 140 x P 200	D1	■	■
		D2	■	■
		D3	■	■
		D4	■	■
		D6	■	■
MY BED SINGLE	ingombro totale: L 112 x P 220 x H 95 interno giroletto: L 102 x P 202 materasso consigliato: L 100 x P 200	D1	■	■
		D2	■	■
		D3	■	■
		D4	■	■
		D6	■	■

FINITURE DISPONIBILI:

A1: noce senza nodi, noce con nodi

A2: rovere senza nodi, rovere con nodi, ciliegio, acero

D1: tessuto: canvas, divina melange 2, hallingdal 65, velluto harald

D2: tessuto: maple

D3: pelle: camoscio, cristal

D4: pelle: nabuk, utah

D6: pelle cliente, tessuto cliente

MY BED DOUBLE - MY BED FRENCH

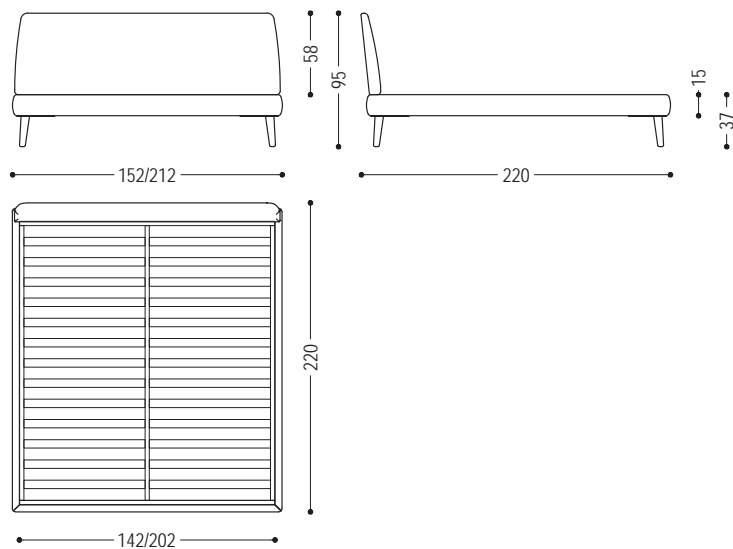

MY BED SINGLE

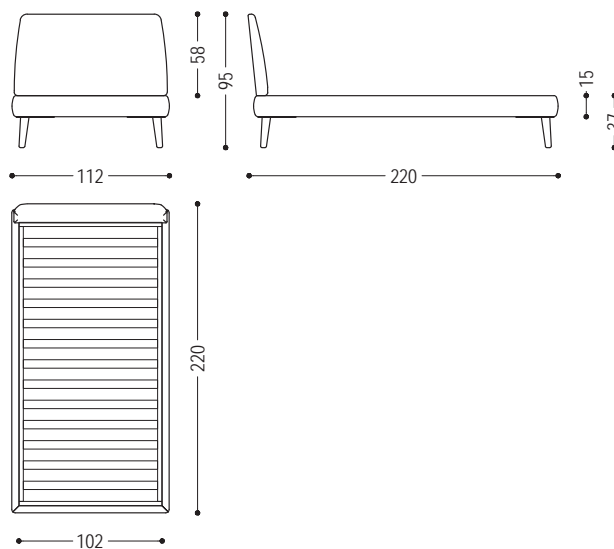

LEGNO

A1

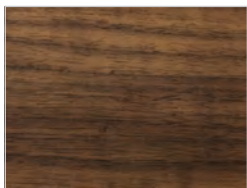

noce senza nodi



noce con nodi

A2

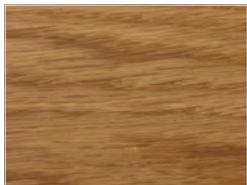

rovere senza nodi

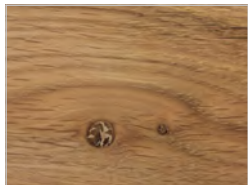

rovere con nodi

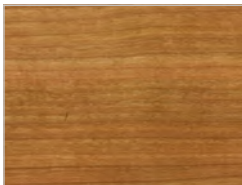

ciliegio

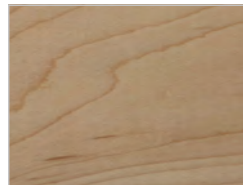

acero

PELLE / TESSUTO

D1



tessuto canvas:
114

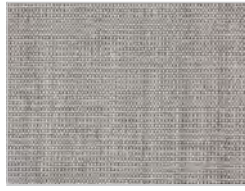

tessuto canvas:
124

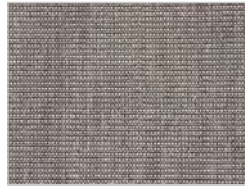

tessuto canvas:
134

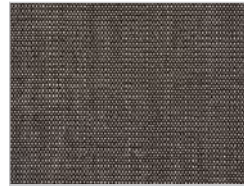

tessuto canvas:
154



tessuto canvas:
174

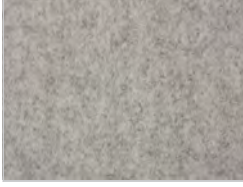

tessuto divina melange 2:
120

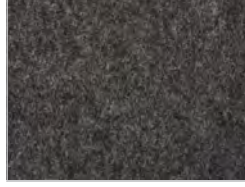

tessuto divina melange 2:
170

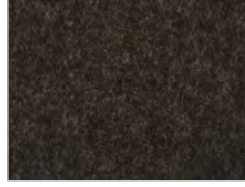

tessuto divina melange 2:
180

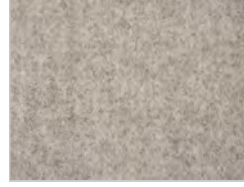

tessuto divina melange 2:
220

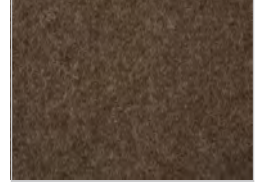

tessuto divina melange 2:
260



tessuto divina melange 2:
280



tessuto hallingdal 65:
103



tessuto hallingdal 65:
116



tessuto hallingdal 65:
130

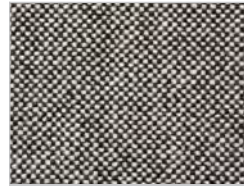

tessuto hallingdal 65:
166



tessuto hallingdal 65:
180



tessuto velluto harald:
182



tessuto velluto harald:
242



tessuto velluto harald:
283



tessuto velluto harald:
443



tessuto velluto harald:
512



tessuto velluto harald:
552



tessuto velluto harald:
582



tessuto velluto harald:
792



tessuto velluto harald:
982

MY BED | FINITURE DISPONIBILI

D2



tessuto maple:
112



tessuto maple:
132



tessuto maple:
142



tessuto maple:
162



tessuto maple:
192



tessuto maple:
222



tessuto maple:
232



tessuto maple:
362

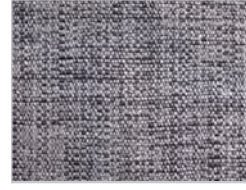

tessuto maple:
742



tessuto maple:
792

D3

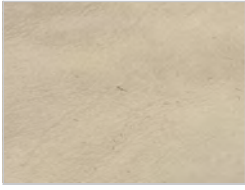

pelle camoscio:
1

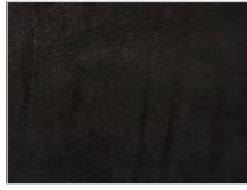

pelle camoscio:
10

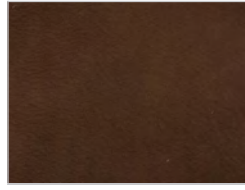

pelle camoscio:
11



pelle camoscio:
26

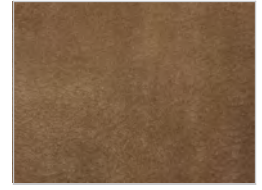

pelle camoscio:
27



pelle camoscio:
28



pelle camoscio:
31



pelle cristal:
13



pelle cristal:
14



pelle cristal:
17

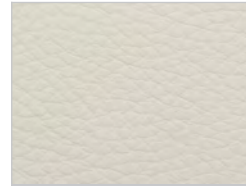

pelle cristal:
18



pelle cristal:
37



pelle cristal:
49



pelle cristal:
51



pelle cristal:
65

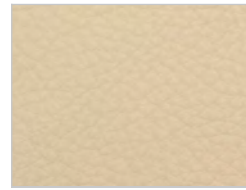

pelle cristal:
70

MY BED | FINITURE DISPONIBILI

D4					
	<p>pelle nabuk: 6</p>	<p>pelle nabuk: 12</p>	<p>pelle nabuk: 15</p>	<p>pelle nabuk: 18</p>	<p>pelle nabuk: 23</p>
					
	<p>pelle nabuk: 27</p>	<p>pelle nabuk: 28</p>	<p>pelle nabuk: 30</p>	<p>pelle nabuk: 36</p>	<p>pelle nabuk: 42</p>
					
	<p>pelle utah: 101</p>	<p>pelle utah: 102</p>	<p>pelle utah: 103</p>	<p>pelle utah: 104</p>	<p>pelle utah: 105</p>
					
	<p>pelle utah: 106</p>	<p>pelle utah: 107</p>	<p>pelle utah: 108</p>		