



EN: Barstool with backrest arch that perfectly joins the seat of solid ash wood with upholstered seat. Steel rod frame

IT: Sgabello on schienale ad arco in legno curvato che si innesta in una soluzione di continuità al sedile in massello con seduta imbottita. Struttura a slitta in tondino d'acciaio

DE: Barhocker mit gekurvter Rückenlehne aus gebogenem Holz, die sich kontinuierlich übergehend mit dem Sitz aus massivem Eschenholz und der gepolsterten Sitzfläche verbindet. Stahlstabgestell

FR: Tabouret à dossier cintré en bois courbé qui se joint à une solution de continuité au siège en bois massif à assise rembourrée. Structure en fil d'acier

ES: Taburete con respaldo arqueado en madera curvada que se inserta en una solución de continuidad al asiento de madera maciza tapizado. Estructura de varillas de acero

mm - in

• 2858/A



• 2859/A

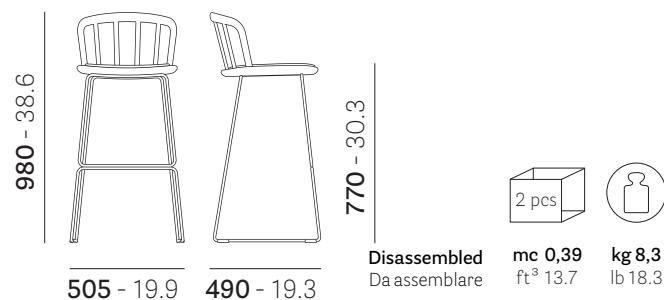

MATERIALS

Materiali
Materialien
Matériaux
Materiales

• SEAT - SEDUTA - SITZ - ASSISE - ASIENTO

EN: Solid Ash

IT: Masello di frassino
DE: Massivem Eschenholz
FR: Bois de frêne
ES: Fresno macizo

WOOD FINISH - FINITURA LEGNO - HOLZ AUSFÜHRUNG - FINITION BOIS - ACABADO MADERA

EN: Water-based paint, matt finish (5 gloss), anti-scratch

IT: Verniciatura a base acqua, finitura opaca (5 gloss), antigraffio
DE: Lack auf Wasserbasis, Ausführung matt (5 gloss), kratztes
FR: Peinture à base d'eau, finition mate (5 gloss), anti-rayures
ES: Pintura a base de agua, acabado mate (brillo 5), anti-arañazos



EN: Lacquered visible grains

IT: Laccato poro aperto
DE: Laqué pore ouvert
FR: Offenporig lackiert
ES: Lacado poro abierto

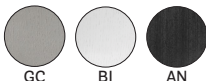

- **FRAME - TELAIO - STRUKTUR - STRUCTURE - ARMAZÓN**

EN: Steel, rod Ø11 mm
 IT: Acciaio, tondino Ø11 mm
 DE: Stahl, rundes Rohrgestell Ø11 mm
 FR: Acier, fil Ø11 mm
 ES: Acero, varilla Ø11 mm

FRAME FINISH - FINITURA TELAIO - AUSFÜHRUNG DER STRUKTUR - FINITIONS STRUCTURE - ACABADO ARMAZÓN

EN: Powder coating
 IT: Verniciato con polvere
 DE: Pulverbeschichtet
 FR: Époxy à poudre
 ES: Barnizado con polvo



EN: For full range of color available see finishing legend on the website
 IT: Per tutta la gamma di colori disponibili vedere legenda finiture sul sito web

- **UPHOLSTERY - IMBOTTITURA - GEPOLSTERT - TAPISSERIE - TAPICERÍA**

EN: Seat upholstered in flexible expanding polyurethane (density 50 kg/m³) fire retardant (class 1 im, crib 5), covered with fabric.

IT: Sedile imbottito in poliuretano flessibile (densità 50 kg/m³) ignifugo (classe 1 im, crib 5) rivestito in tessuto
 DE: Gepolsterter Sitz aus Polyurethan (dichte 50 kg/m³) feuerfest (Klasse 1 IM, Crib 5), mit Stoff bezogen
 FR: Siège rembourré en polyuréthane en polyuréthane souple (densité 50 kg/m³), ignifuge (classe 1 IM, Crib 5), recouverts de tissu

ES: Asiento tapizado con espuma de poliuretano ignífugo flexible (densidad 50 kg/m³), ignífugo (clase 1IM, Crib 5), forrado de tela

FABRIC - TESSUTO - STOFF - TISSU - TEJIDO

Cat. A - C - D40÷D44 - E - G - H - N - P

- **FEET - PIEDINI - GLEITER - PATINS - TACOS**

EN: Tecnopolymer, with anti-rotation pin, black or white
 IT: Tecnopolimero, con perno antirotazione, bianco o nero
 DE: Technopolymer, mit nicht drehbar Kern, schwarz oder weiß
 FR: Technopolymère, avec pivot antirotation, blanc ou noir
 ES: Tecnopolímero, con perno antirrotacional, blanco o negro

DESIGN
CMP Design

REGULATIONS AND CERTIFICATES

Normative e Certificazioni
Bestimmungen und Zertifikat
Normatives et certifications
Normativas y certificados

• PRODUCT CERTIFICATIONS - CERTIFICAZIONI DI PRODOTTO - PRODUKTZERTIFIZIERUNGEN - CERTIFICATIONS DE PRODUITS - CERTIFICACIONES DE PRODUCTO

EN: FSC® certified product
IT: Prodotto certificato FSC®
DE: Zertifiziertes Produkt FSC®
FR: Produit certifié FSC®
ES: Producto certificado FSC®



• ENVIRONMENTAL IMPACT - IMPATTO AMBIENTALE - UMWELTBELASTUNG - IMPACT DUR L'ENVIRONNEMENT - IMPACTO AMBIENTAL

MATERIAL Materiale	Kg WEIGHT Peso	% TOTAL ITEM Totale articolo	MATERIAL RECYCLABILITY Riciclabilità del materiale	% MINIMUM RECYCLED AT ORIGIN Minima riciclato all'origine	% RECYCLABLE END OF PRODUCT LIFE Riciclabile fine vita prodotto
Steel Acciaio	4,32	52,27	YES	33,2	100
Tecopolymer Tecnopolimero	0,01	0,13	YES	0	100
Solid wood Legno massello	3,37	40,82	YES	0	100
Polyurethane foam Poliuretano espanso	0,13	1,57	NO	0	0
Plywood Legno multistrato	0,37	4,48	YES	0	100
Fabric 350 g/m² Tessuto 350 g/m ²	0,06	0,73	NO	0	0
TOTAL TOTALE	8,26 Kg	--	--	17,4 %	97,7 %

EN: Percentages referred to 2859/A
IT: Percentuali riferite al 2859/A

• COMPANY CERTIFICATIONS - CERTIFICAZIONI AZIENDALI - UNTERNEHMENSZERTIFIZIERUNGEN - CERTIFICATIONS D'ENTREPRISE - CERTIFICACIONES DE LA EMPRESA

ISO 14001
Environmental management system
Sistema di gestione ambientale



ISO 9001
Quality management system
Sistema di gestione della qualità



Reproduction of this document is strictly prohibited without prior written authorisation from Pedrali SpA. Sizes, weights and finishes may change without previous notice.
È vietata la riproduzione del seguente documento senza previa autorizzazione scritta da parte di Pedrali SpA. Dimensioni, pesi e finiture possono variare senza alcun preavviso.

ST_INV_2858-A_2859-A_2021.0

DESIGN
CMP Design



EN: Barstool with trestle-style in solid ash wood with swivelling mechanism, upholstered seat and steel circular footrest

IT: Sgabello a trespolo in massello di frassino con meccanismo girevole, seduta imbottita e poggipiedi circolare in acciaio

DE: Barhocker mit trestle-Struktur aus massivem Eschenholz mit Drehmechanismus, Sitz gepolstert und runder Fußstütze aus Stahl

FR: Tabouret avec structure à tréteau en frêne massif avec mécanisme pivotant, assise rembourrée et repose-pieds circulaire en acier

ES: Taburete de caballete de fresno macizo con mecanismo giratorio, asiento tapizado y reposapiés circular de acero

mm - in

• 2848/A

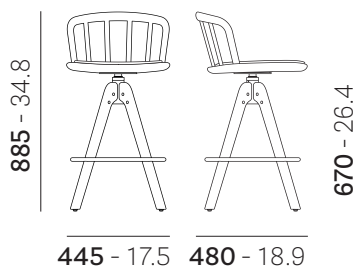

Disassembled
Da assemblare

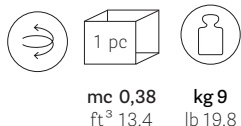

• 2849/A

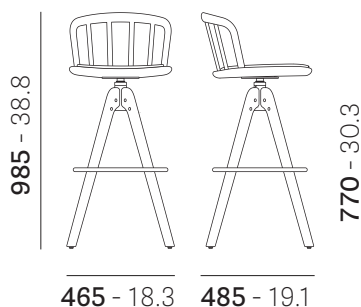

Disassembled
Da assemblare

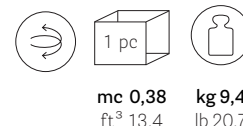

MATERIALS

Materiali
Materialien
Matériaux
Materiales

• SEAT - SEDUTA - SITZ - ASSISE - ASIENTO

EN: Ash seat with padded cushion with flexible polyurethane (density 50 kg/m³), fire-retardant (class 1 IM, Crib 5), covered with fabric

IT: Seduta in frassino con cuscino imbottito con poliuretano espanso flessibile (densità 50 kg/m³), ignifugo (classe 1 IM, Crib 5), rivestito in tessuto

DE: Sitz aus Esche mit Kissen aus flexibel Polyurethan (Dichte 50 kg/m³), feuerfest (Klasse 1 IM, Crib 5), mit Kernleder bezogen

FR: Assise en frêne avec coussin rembourré en polyuréthane expansé flexible (densité 50 kg/m³), ignifuge (classe 1 IM, Crib 5), recouverts de cuir naturel

ES: Asiento de fresno con cojín tapizado de espuma de poliuretano flexible (densidad 50 kg/m³), ignifugo (clase 1IM, Crib5), forrado de tela

FABRIC - TESSUTO - STOFF - TISSU - TEJIDO

Cat. A - C - D40÷D44 - E - G - H - N - P

EN: For more information see finishing legend on the website

IT: Per maggiori informazioni vedere legenda finiture sul sito web

• FRAME - TELAIO - STRUKTUR - STRUCTURE - ARMAZÓN

EN: Four solid ash legs frame, with swivel mechanism with automatic return

IT: Telaio a trespolo, 4 gambe in frassino, con meccanismo girevole con ritorno

DE: Gestell mit 4 Füße aus Esche, mit Drehmechanismus mit Rückkehr, epoxy-polyester pulverbeschichtet

FR: Structure tréteau, 4 pieds en frêne, avec mécanisme pivotant et retour en position

ES: Armazón de 4 patas de fresno, giratorio con mecanismo de retorno

DESIGN
CMP Design**WOOD FINISH - FINITURA LEGNO - HOLZ AUSFÜHRUNG - FINITION BOIS - ACABADO MADERA**

EN: Water-based paint, matt finish (5 gloss), anti-scratch
 IT: Verniciatura a base acqua, finitura opaca (5 gloss), antigraffio
 DE: Lack auf Wasserbasis, Ausführung matt (5 gloss), kratzfest
 FR: Peinture à base d'eau, finition mate (5 gloss), anti-rayures
 ES: Pintura a base de agua, acabado mate (brillo 5), anti-arañazos

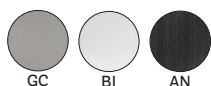

EN: Lacquered visible grains
 IT: Laccato poro aperto
 DE: Laqué pore ouvert
 FR: Offenporig lackiert
 ES: Lacado poro abierto

**• FOOTREST - POGGIAPIEDI - FUßRING - REPOSE-PIEDS - REPOSA PIES**

EN: Stainless steel, tube Ø16 mm
 IT: Acciaio inox, tubo Ø16 mm
 DE: Edelstahl, Rohr Ø16 mm
 FR: Acier inoxydable, tube Ø16 mm
 ES: Acero inoxidable, tubo Ø16 mm

FOOTREST FINISH - FINITURA POGGIAPIEDI - AUSFÜHRUNG DER FUSSTÜTZE - FINITIONS REPOSE-PIEDS - ACABADO REPOSA PIES

EN: Powder coating
 IT: Verniciato con polvere
 DE: Pulverbeschichtet
 FR: Époxy à poudre
 ES: Barnizado con polvo

**• FEET - PIEDINI - GLEITER - PATINS - TACOS**

EN: Feet with interchangeable insert in felt type "15", suitable for delicate and sensitive floors (wood, ceramic, marble) on request feet with interchangeable insert type "17" in plastic material, suitable for soft floors (carpet, rugs) or rough (concrete, metal)

IT: Piedini con inserto intercambiabile in feltro tipo "15", adatti per pavimenti delicati e sensibili (legno, ceramica, marmo), a richiesta piedino con inserto intercambiabile in materiale plastico tipo "17", adatti per pavimenti morbidi (moquette, tappeti) o ruvidi (cemento, metallo)

DE: Gleiter mit austauschbaren Einsatz aus Filz Typ "15", für sanfte und zartfühlende Boden geeignet (Holz, Keramik, Marmor), nach Bedarf Gleiter mit Einsatz aus Kunststoff Typ "17" auch zur Verfügung, für weichen Boden geeignet (Teppichboden, Moquette) oder groben Boden (Metall, Beton)

FR: Patins avec insert interchangeable en feutre type "15", pour sols délicats et sensibles (bois, marbre, céramique), sur demande patin avec interchangeable en matériau plastique type "17", valable pour les sols plus doux (moquette, tapis) ou rugueux (béton, métal)

ES: Tacos con inserto intercambiabile de feltro tipo "15", aptos para pisos delicados y sensibles (madera, cerámica, mármol), bajo pedido tacos con insertos intercambiables de plástico tipo "17", aptos para pisos suaves (moquetas, alfombras) o ásperos (hormigón, metal)

DESIGN
CMP Design

REGULATIONS AND CERTIFICATES

Normative e Certificazioni
Bestimmungen und Zertifikat
Normatives et certifications
Normativas y certificados

• PRODUCT CERTIFICATIONS - CERTIFICAZIONI DI PRODOTTO - PRODUKTZERTIFIZIERUNGEN - CERTIFICATIONS DE PRODUITS - CERTIFICACIONES DE PRODUCTO

EN: FSC® certified product
IT: Prodotto certificato FSC®
DE: Zertifiziertes Produkt FSC®
FR: Produit certifié FSC®
ES: Producto certificado FSC®



• ENVIRONMENTAL IMPACT - IMPATTO AMBIENTALE - UMWELTBELASTUNG - IMPACT DUR L'ENVIRONNEMENT - IMPACTO AMBIENTAL

MATERIAL Materiale	Kg WEIGHT Peso	% TOTAL ITEM Totale articolo	MATERIAL RECYCLABILITY Riciclabilità del materiale	% MINIMUM RECYCLED AT ORIGIN Minima riciclato all'origine	% RECYCLABLE END OF PRODUCT LIFE Riciclabile fine vita prodotto
Steel Acciaio	2,58	27,44	YES	33,2	100
Die-cast aluminium Alluminio pressofuso	0,207	2,20			
Polyethylene Poliethylene	0,0036	0,04	YES	0	100
Polyurethane foam Poliuretano espanso	0,13	1,38	NO	0	0
Solid wood Legno massello	6	63,82	YES	0	100
Plywood Multistrato	0,37	3,94	YES	0	100
Fabric 490 g/m Tessuto 490 g/m	0,11	1,15	NO	0	0
Felt Feltro	0,0028	0,03	NO	0	0
TOTAL TOTALE	9,4 Kg	--	--	11,2 %	97,4 %

EN: Percentages referred to 2849/A
IT: Percentuali riferite al 2849/A

• COMPANY CERTIFICATIONS - CERTIFICAZIONI AZIENDALI - UNTERNEHMENSZERTIFIZIERUNGEN - CERTIFICATIONS D'ENTREPRISE - CERTIFICACIONES DE LA EMPRESA

ISO 14001
Environmental management system
Sistema di gestione ambientale



ISO 9001
Quality management system
Sistema di gestione della qualità





EN: Barstool with upholstered seat and solid ash four-leg frame and stainless steel footrest

IT: Sgabello con seduta imbottita e struttura a quattro gambe in massello di frassino e poggiapiedi in acciaio inox

DE: Hocker mit gepolstertem Sitz und Vierfußgestell aus massivem Eschenholz und Fußstütze aus Edelstahl

FR: Tabouret avec assise rembourrée et structure à quatre pieds en bois de frêne massif et repose-pieds en acier inoxydable

ES: Taburete con asiento y estructura de cuatro patas en madera maciza de fresno y reposapiés en acero inoxidable

mm - in

• 2838/A



mc 0,29 kg 6,4
ft³ 10.2 lb 14.1

• 2839/A

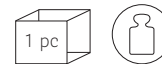

mc 0,29 kg 6,6
ft³ 10.2 lb 14.5

MATERIALS

Materiali
Materialien
Matériaux
Materiales

• SEAT - SEDUTA - SITZ - ASSISE - ASIENTO

EN: Cushion with beech plywood inner structure, padded with flexible polyurethane (density 50 kg/m³), fire-retardant (class 1 IM, Crib 5), covered with fabric

IT: Cuscino con struttura interna in multistrato di faggio, imbottito con poliuretano espanso flessibile (densità 50 kg/m³), ignifugo (classe 1 IM, Crib 5), rivestito in tessuto

DE: Kissen mit Innenstruktur aus Buchensperholz, gepolstert mit flexibel Polyurethan (Dichte 50 kg/m³), feuerfest (Klasse 1 IM, Crib 5), mit Kernleder bezogen

FR: Coussin avec structure interne en contreplaqué de hêtre, rembourré de polyuréthane expansé flexible (densité 50 kg/m³), ignifuge (classe 1 IM, Crib 5), recouverts de cuir naturel

ES: Cojín con estructura interior de madera de haya contrachapada, tapizado de espuma de poliuretano flexible (densidad 50 kg/m³), ignífugo (clase 1IM, Crib5), forrado de tela

FABRIC - TESSUTO - STOFF - TISSU - TEJIDO

Cat. A - C (excluding C36÷C39) - D40÷D44 - E - G - H - N - P

EN: For more information see finishing legend on the website

IT: Per maggiori informazioni vedere legenda finiture sul sito web

• FRAME - TELAIO - STRUKTUR - STRUCTURE - ARMAZÓN

EN: Solid Ash

IT: Masello di frassino

DE: Massivem Eschenholz

FR: Bois de frêne

ES: Fresno macizo

EN: Wooden parts have jointed components

IT: Le parti in legno presentano componenti giuntati

WOOD FINISH - FINITURA LEGNO - HOLZ AUSFÜHRUNG - FINITION BOIS - ACABADO MADERA**EN: Water-based paint, matt finish (5 gloss), anti-scratch**

IT: Verniciatura a base acqua, finitura opaca (5 gloss), antigraffio

DE: Lack auf Wasserbasis, Ausführung matt (5 gloss), kratzfest

FR: Peinture à base d'eau, finition mate (5 gloss), anti-rayures

ES: Pintura a base de agua, acabado mate (brillo 5), anti-arañazos

**EN: Lacquered visible grains**

IT: Laccato poro aperto

DE: Laqué pore ouvert

FR: Offenporig lackiert

ES: Lacado poro abierto

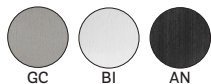

- **FOOTREST - POGGIAPIEDI - FÜBRING - REPOSE-PIEDS - REPOSA PIES**

EN: Stainless steel, tube Ø16 mm

IT: Acciaio inox, tubo Ø16 mm

DE: Edelstahl, Rohr Ø16 mm

FR: Acier inoxydable, tube Ø16 mm

ES: Acero inoxidable, tubo Ø16 mm

FOOTREST FINISH - FINITURA POGGIAPIEDI - AUSFÜHRUNG DER FUSSTÜTZE - FINITIONS REPOSE-PIEDS - ACABADO REPOSA PIES**EN: Brushed stainless steel**

IT: Acciaio inox satinato

DE: Edelstahl satiniert

FR: Acier inoxydable satiné

ES: Acero inoxidable satinado



- **FEET - PIEDINI - GLEITER - PATINS - TACOS**

EN: Feet with interchangeable insert in felt type "15", suitable for delicate and sensitive floors (wood, ceramic, marble) on request feet with interchangeable insert type "17" in plastic material, suitable for soft floors (carpet, rugs) or rough (concrete, metal)

IT: Piedini con inserto intercambiabile in feltro tipo "15", adatti per pavimenti delicati e sensibili (legno, ceramica, marmo), a richiesta piedino con inserto intercambiabile in materiale plastico tipo "17", adatti per pavimenti morbidi (moquette, tappeti) o ruvidi (cemento, metallo)

DE: Gleiter mit austauschbaren Einsatz aus Filz Typ "15", für sanfte und zartfühlende Boden geeignet (Holz, Keramik, Marmor), nach Bedarf Gleiter mit Einsatz aus Kunststoff Typ "17" auch zur Verfügung, für weichen Boden geeignet (Teppichboden, Moquette) oder groben Boden (Metall, Beton)

FR: Patins avec insert interchangeable en feutre type "15", pour sols délicats et sensibles (bois, marbre, céramique), sur demande patin avec interchangeable en matériau plastique type "17", valable pour les sols plus doux (moquette, tapis) ou rugueux (béton, métal)

ES: Tacos con inserto intercambiabile de fieltro tipo "15", aptos para pisos delicados y sensibles (madera, cerámica, mármol), bajo pedido tacos con insertos intercambiables de plástico tipo "17", aptos para pisos suaves (moquetas, alfombras) o ásperos (hormigón, metal)

DESIGN
CMP Design

REGULATIONS AND CERTIFICATES

Normative e Certificazioni
Bestimmungen und Zertifikat
Normatives et certifications
Normativas y certificados

- **RESISTANCE TEST - TEST DI RESISTENZA - TEST ZUR BELASTBARKEIT - TEST DE RÉSISTANCE - PRUEBA DE RESISTENCIA**

EN 1728:2012, 6.4 - EN 16139:2013, L2
EN 1728:2012, 6.5 - EN 16139:2013, L2
EN 1728:2012, 6.17 - EN 16139:2013, L2
EN 1728:2012, 6.21 - EN 16139:2013, L2

- **PRODUCT CERTIFICATIONS - CERTIFICAZIONI DI PRODOTTO - PRODUKTZERTIFIZIERUNGEN - CERTIFICATIONS DE PRODUITS - CERTIFICACIONES DE PRODUCTO**

EN: FSC® certified product
IT: Prodotto certificato FSC®
DE: Zertifiziertes Produkt FSC®
FR: Produit certifié FSC®
ES: Producto certificado FSC®



- **ENVIRONMENTAL IMPACT - IMPATTO AMBIENTALE - UMWELTBELASTUNG - IMPACT DUR L'ENVIRONNEMENT - IMPACTO AMBIENTAL**

MATERIAL Materiale	Kg WEIGHT Peso	% TOTAL ITEM Totale articolo	MATERIAL RECYCLABILITY Riciclabilità del materiale	% MINIMUM RECYCLED AT ORIGIN Minima riciclato all'origine	% RECYCLABLE END OF PRODUCT LIFE Riciclabile fine vita prodotto
Steel Acciaio	0,8523	29,67	YES	33,2	100
Polyethylene Poliethylene	0,0036	0,04	YES	0	100
Polyurethane foam Poliuretano espanso	0,13	1,38	NO	0	0
Solid wood Legno massello	5,13	63,80	YES	0	100
Plywood Multistrato	0,37	3,93	YES	0	100
Fabric 490 g/m Tessuto 490 g/m	0,11	1,15	NO	0	0
Felt Feltro	0,0016	0,03	NO	0	0
TOTAL TOTALE	6,60 Kg	--	--	4,3 %	96,4 %

EN: Percentages referred to 2839/A
IT: Percentuali riferite al 2839/A

- **COMPANY CERTIFICATIONS - CERTIFICAZIONI AZIENDALI - UNTERNEHMENSZERTIFIZIERUNGEN - CERTIFICATIONS D'ENTREPRISE - CERTIFICACIONES DE LA EMPRESA**

ISO 14001
Environmental management system
Sistema di gestione ambientale

ISO 9001
Quality management system
Sistema di gestione della qualità

