

Regolo

design Lievore Altherr Molina

SOVET



ITALIA

Tavolo con top disponibile in vetro extrachiaro trasparente o stratificato fumé o bronzo. Base composta da un elemento in legno, varie finiture, e un elemento in vetro stratificato laccato nero.



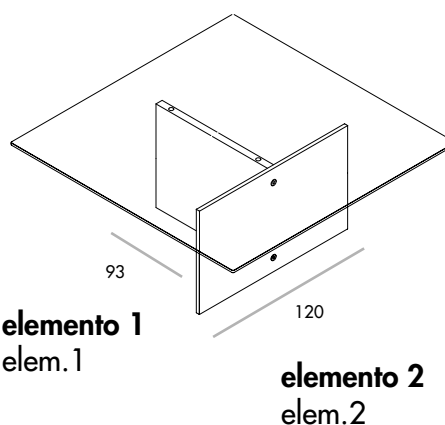
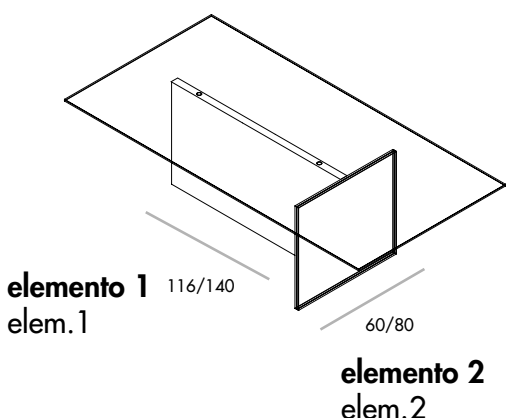





Dining table with extralight clear or smoked/bronzed laminated glass top. Base composed of a wooden element, various finishes, and a black lacquered laminated glass element.

FORME E DIMENSIONI / SHAPES AND DIMENSIONS



-  200x100x74h
-  240x120x74h
-  250x100x74h

-  180x180x74h

FINITURE ELEMENTO 1 / ELEMENT 1 FINISHES	FINITURE ELEMENTO 2 / ELEMENT 2 FINISHES	FINITURE TOP / TOP FINISHES
<p>LEGNO WOOD</p> <p>RN / RG / WG / NC</p>	<p>VETRO STRATIFICATO LAMINATED GLASS</p> <p>TFN1</p>	<p>VETRO EXTR. / VETRO FUMÉ / VETRO BRONZO EXTR. GLASS / SMOKED GLASS / BRONZED GLASS</p> <p>TETE Sp./Th. 15 mm / TFTF Sp./Th. 8+8 mm TBTB Sp./Th. 8+8 mm</p>
 <p>RN</p>  <p>RG</p>  <p>WG</p>  <p>NC</p>	 <p>TFN1</p>	 <p>TETE</p>  <p>TFTF</p>  <p>TBTB</p>