

TALENT

— By Alegre Design —

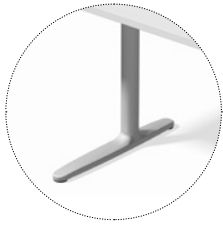



TALENT SERIE 100 - Fixed desks with levellers

Straight desks, 60 cm depth

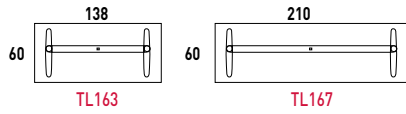

Straight desks, 69 cm depth

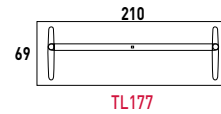

Straight progressive desks, 60 cm depth

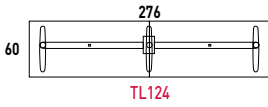

TALENT SERIE 300 - Fixed desks with castors and folding desk-top

Straight desks, 69 cm depth

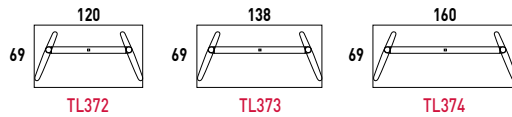

Straight desks, 80 cm depth

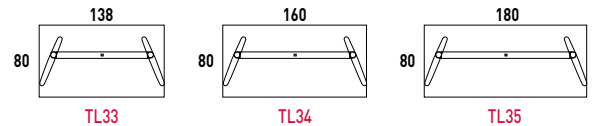

TALENT SERIE 500 - Height adjustable desks with castors and folding desk-top

Straight desks, 69 cm depth

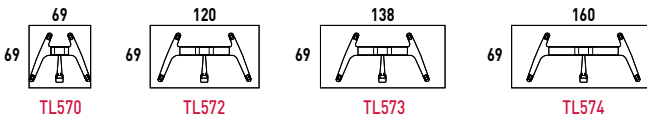

Straight desks, 69 cm depth with wiring access incorporated

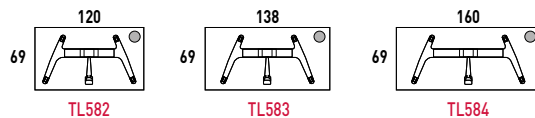

AVAILABLE FINISHES:

Desk-top Finishes



Structure Finishes

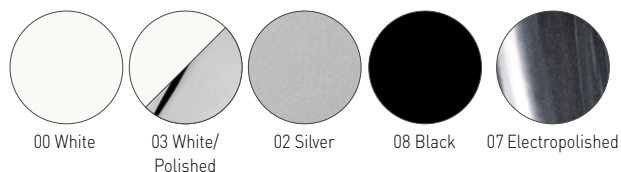

TALENT SERIE 100 - Fixed desks with levellers



- 1 25 mm melamine desk-top with straight PVC edge.
- 2 3 mm folded steel plate bracket in a white, black and aluminised finish with an epoxy paint coating.
- 3 70x40 and e=2 steel tube recessed crossbar with bumper edge to safely support the desk top.
- 4 Ø60 mm extruded aluminium column in a white, black and aluminised finish with an epoxy paint coating.
- 5 Straight aluminium injection legs in a white, black or aluminised finish, with an epoxy paint coating and polished aluminium finish.
- 6 Ø46mm levellers with non-skid patch.

Optional Accessories:

Cable Access Management



Ø80mm "U" cable access



Push Latch "T" cable access



Metal tray for "T" type cable access



Individual metal cable tray



Polypropylene flexible cable routing

Modesty Panel



Melamine or steel

Desk Top Screens



TALENT offers a variety of options in screens. Fully upholstered, with aluminium profiles or rails for attaching 3rd-level elements, melamine, glass or methacrylate

CPU Holder



Fixed to the cross beam

Linking Desks



Quick linking system. The desks are prepared to be linked laterally and frontally. They are fixed using an e=4mm plastic bracket

TALENT SERIE 300 - Fixed desks with castors and folding desk-top

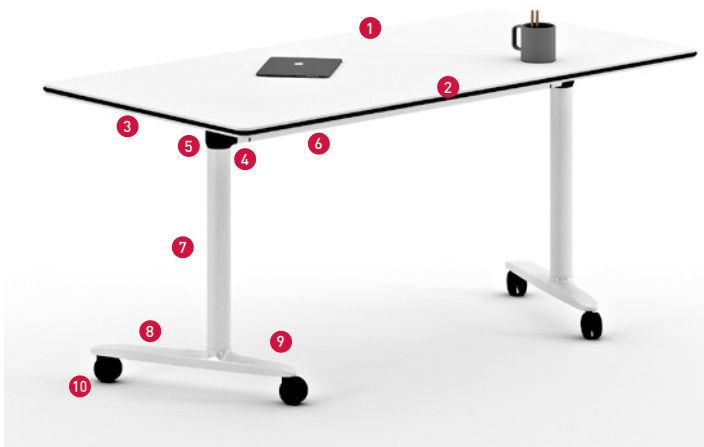

- 1 25 mm melamine desk-top with PVC edge and shock absorbing rubber.
- 2 Folding desk top with locking/unlocking system.
- 3 Aluminium injection bracket in a white, black and aluminised finish with an epoxy paint coating.
- 4 Injected aluminium corner joint for attaching columns and crossbars.
- 5 Polypropylene vertical stacking cap.
- 6 73x70 and e=2 mm extruded aluminium recessed crossbar with bumper to safely support the desk top.
- 7 Ø60 mm extruded aluminium column in a white, black, aluminised finish with an epoxy paint coating and electropolished with polished finish.
- 8 Straight aluminium injection legs in a white, black and aluminised finish with an epoxy paint coating and polished aluminium finish.
- 9 Stacking protection on the legs.
- 10 Black, 65 mm diameter wheels. 2 with brake and 2 without brake.

Positioning legs in an angular position

The standard 300 SERIES offer 2 different angle positions by positioning the feet in 2 positions, so they can be angled or straight depending on the vertical stackability required.

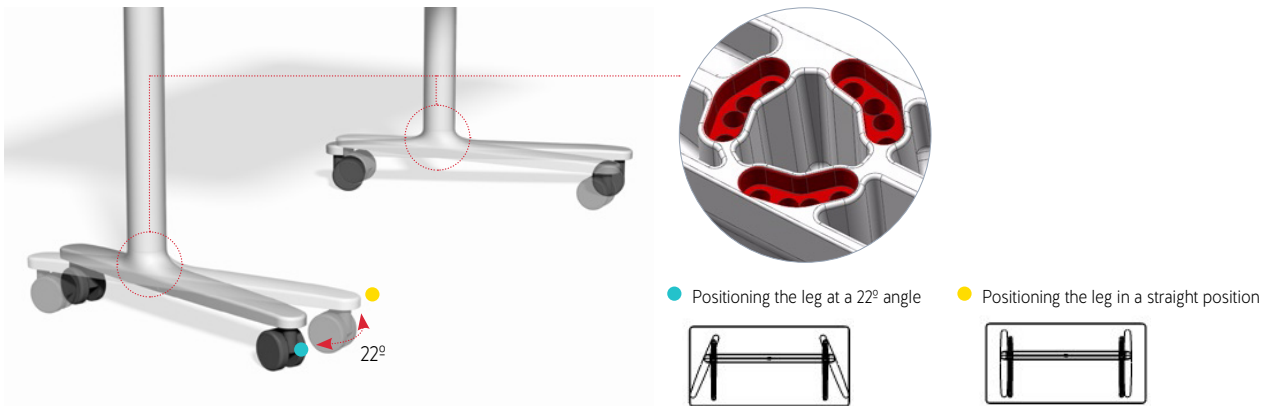

Folding the desk top desk-top:

The 300 SERIES offers a folding system for the work desk-top, using a system in the brackets that features a locking and unlocking position for the mechanism. At the same time, this folding allows the desks to be stacked, thus saving space. The desks come with a protector on the legs for stacking.

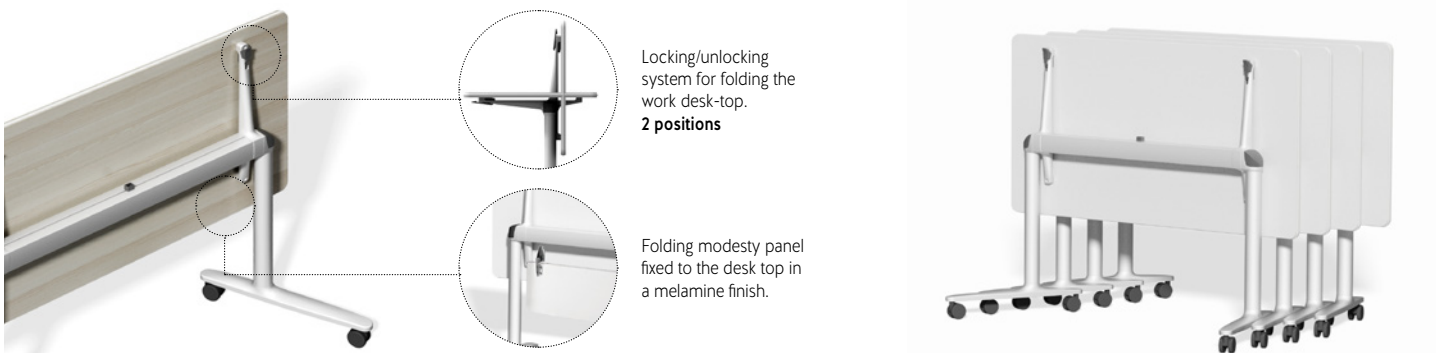

Optional Accessories:

Cable Access Management

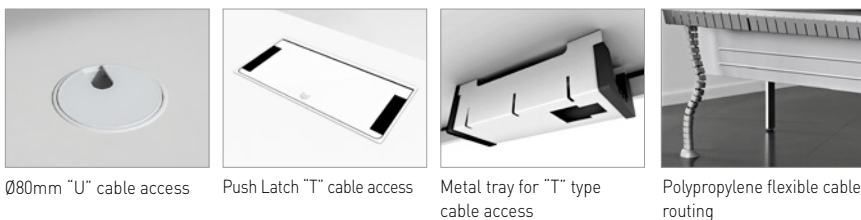

Ø80mm "U" cable access

Push Latch "T" cable access

Metal tray for "T" type cable access

Polypropylene flexible cable routing

Folding Modesty Panel Linking of Desks



Melamine modesty panel

Quick linking. The desks are prepared to be linked laterally and frontally. They are fixed using a e=4mm plastic bracket

Linking device system for desks – TALENT 100 and TALENT 300



TALENT, in its 100 and 300 series, offers a fast linking device system for desks, thus permitting different configurations, making the desks stable and ensuring there is no unwanted movement while they are being used.

The desks are prepared to be linked laterally and frontally, using a e=4mm plastic bracket, which features a quick and simple linking device system.

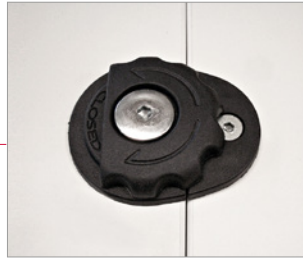

Desk Models with Linking Device Systems

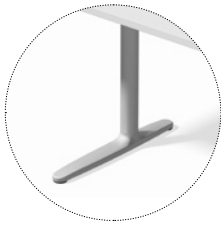

TALENT SERIE 100 - Fixed desks with levellers

Straight desks, 60 cm depth

Straight desks, 69 cm depth

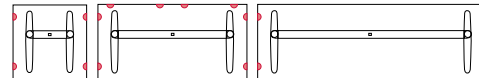
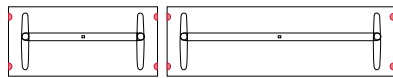

Straight desks, 80 cm depth

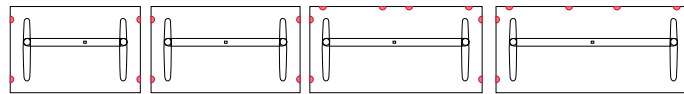

TALENT SERIE 300 - Fixed desks with castors and folding desk-top

Straight desks, 69 cm depth

Straight desks, 80 cm depth

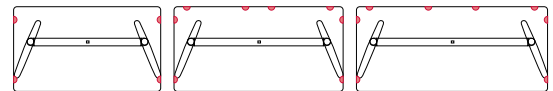
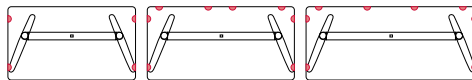

Configuration Examples

Side linking

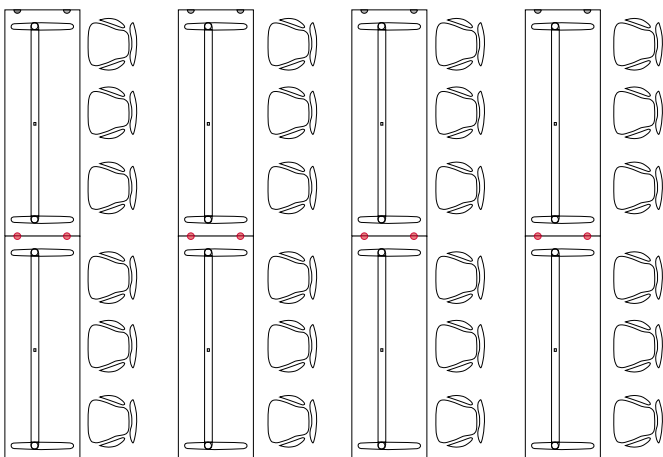

Front and side linking

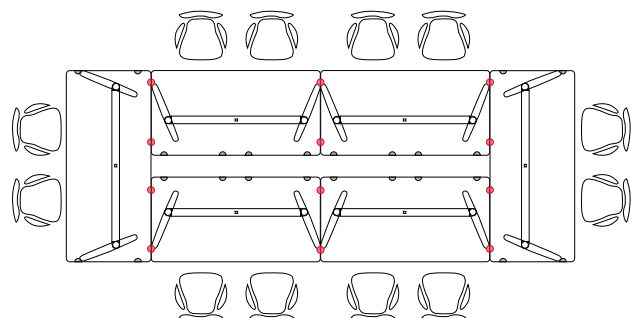

TALENT SERIE 500 - Height adjustable desks with castors and folding desk-top



- 1 25 mm melamine desk-top with PVC bumper edge.
- 2 Folding desk top with locking/unlocking system.
- 3 Aluminium injection bracket in a white, black and aluminised finish with an epoxy paint coating.
- 4 Injected aluminium corner joint for attaching columns and crossbars.
- 5 Polypropilene vertical stacking cap.
- 6 Elevation system in the desk via a gas lift.
- 7 73x70 and e=2 mm extruded aluminium recessed crossbar, with bumper to safely support the desk top.
- 8 Injected aluminium telescopic central column with two 110x80 and 100x70 sections and e=2 mm, featuring gas lift elevation system, in a white, black and aluminised finish with an epoxy paint coating.
- 9 Aluminium injection legs with lateral junction, in a white, black and aluminised finish with an epoxy paint coating and polished aluminium finish.
- 10 Stacking protection on the legs.
- 11 65 mm diameter black wheels. 2 with brakes and 2 without brakes.

Desk Elevation System:

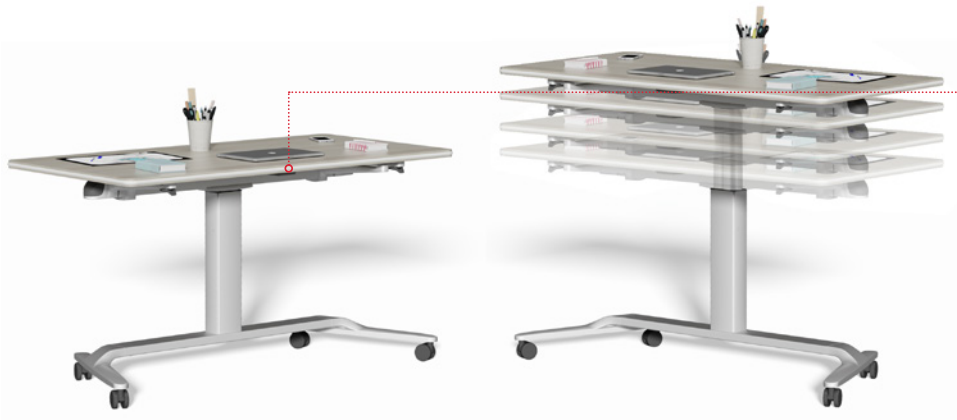

The 500 SERIES has a push button under the desk top that is easily accessible, which allows the desk to be elevated using a gas lift. Height range: 74-104 cm.

Folding the desk top desk-top:

The 500 SERIES offers a folding system for the work desk-top, using a system in the brackets with a locking and unlocking position for the mechanism. At the same time, this folding allows the desks to be stacked, thus saving space. The desks come with a protector on the legs for stacking.

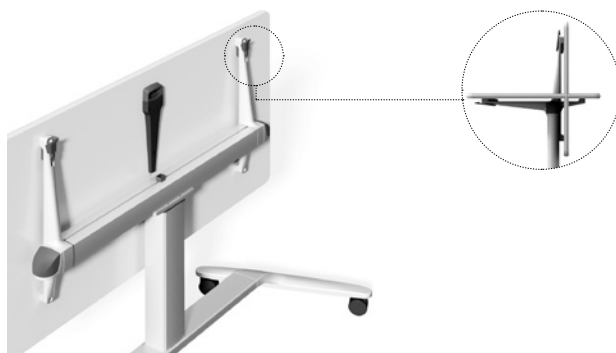

Locking/unlocking system for folding the work desk-top.
2 positions



TALENT SERIE 500 - Height adjustable desks with castors and folding desk-top

Talent Desks with Laminated Writable Desk-top and dry wipeable

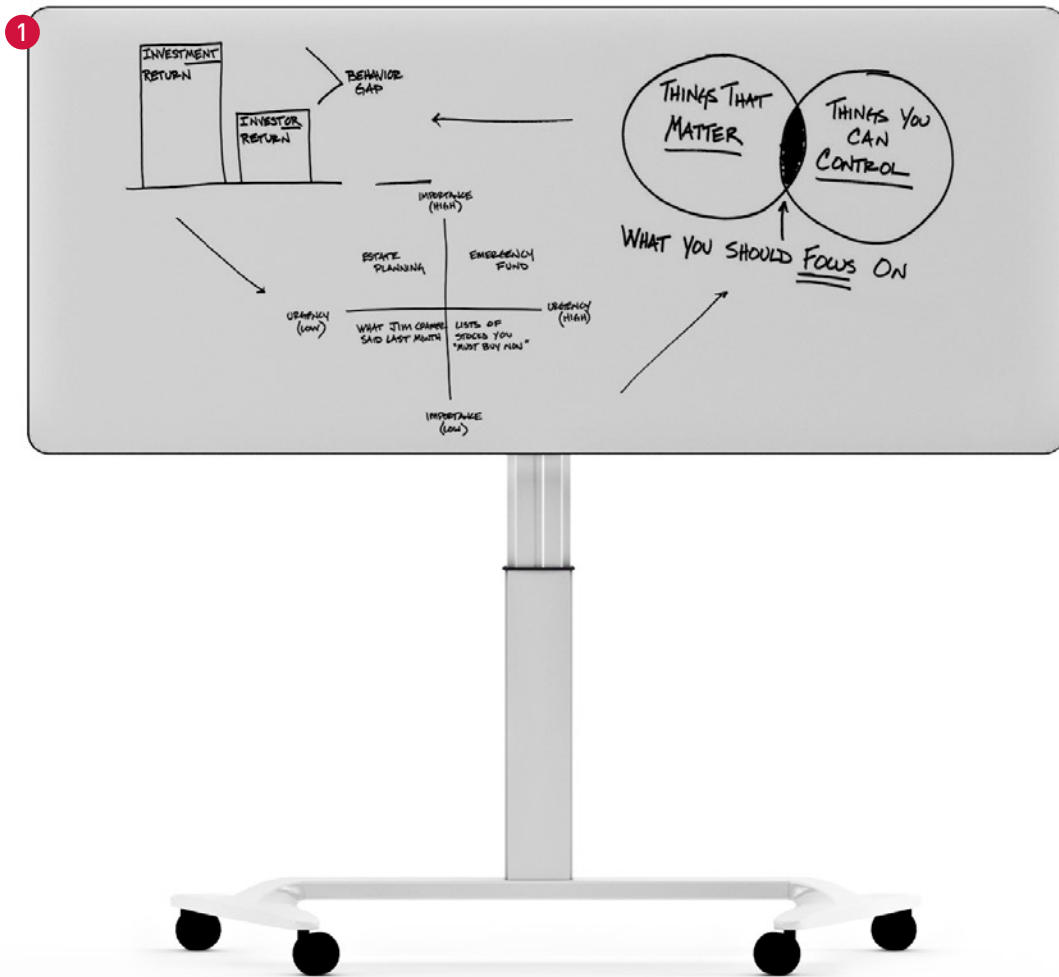

- 1 • 24 mm HPL desk-top with PVC edge and shock-absorbing rubber.
- White laminated melamine desk-top, suitable for writing directly on it with dry erase markers.
- Easily erased and cleaned with a simple cloth or rubber.



Cleaning the Desk-top

Easily erased and cleaned with a simple dry cloth or rubber, even when the writing has been there for a while. The use of chemical products for cleaning the desk-top is not recommended.



Markers for Writing

To correctly write on the desk-top, the use of **dry erase markers** is recommended in order to lengthen the desk desk-top's useful life.

TALENT SERIE 500 - Height adjustable desks with castors, folding desk-top and wiring access incorporated

Talent Desks with connectivity without detracting from mobility



- 1** All models incorporate integrated connection access to the table surface with a plug.

 - High-impact fire-resistant polycarbonate housing.
 - Silver ring as standard
 - Large plastic locking nut that can be tightened by hand Ø79mm
 - 1 x schucko, + 2 USB-charger
 - Dimensions: Ø10,8 x h:15,3cm
- 2** Hook made of 3 mm thick steel plate, anchored to the bracket with capacity to pick up the wiring easily and cleanly.
- 3** Metal riser cables, made of 0,8 mm thick sheet steel, which allows simple wiring guidance, providing visual cleanliness.
- 4** Built-in 3m long cable wrapped in textile cable riser, with zipper system, with additional protection against flames and abrasion.



MATERIALS

Maximum use of materials to eliminate and minimize scraps. Use of recyclable and recycled materials in those components that do not affect the functionality and durability.

Serie 100: **67,24%**
Serie 300: **69,87%**
Serie 500: **62,99%**

RECYCLED MATERIALS



PRODUCTION

Maximum optimization of energy use. Minimal environmental impact. Last generation technological systems. Zero discharge of wastewater. No VOC coatings. Processes free of heavy metals, phosphates, OC and COD.

100%

RECYCLABLE ALUMINIUM, STEEL & WOOD



TRANSPORT

Detachable systems. Volumes that facilitate the optimization of space. Maximum reduction of energy consumption by transport.

100%

RECYCLABLE PACKAGE AND THINNER FREE



USE

Quality and warranty. Long lasting. Replacements available.

EASY

TO CLEAN AND MAINTAIN



DISPOSAL

Waste reduction. Supplier-manufacturer packaging reuse system. Components are easy to be separated. Inks in packaging are water-based, without solvents.

Serie 100: **91,83%**
Serie 300: **97,89%**
Serie 500: **91,32%**

RECYCLABLE MATERIALS

■ **CERTIFICATES AND REFERENCES**

The different programmes get points in different environmental categories to get the LEED certificate or WELL certificate (sustainability, material and resources, water, energy and atmosphere, inner environment quality, innovation and design).



■ **STANDARDS**

Talent 300 has passed tests done in our technical department as well as the tests done in AIDIMA the Technological Institute for furniture. The tests correspond to:

- **UNE-EN 527-1:2011.** Office Furniture. Desks. Part 1: Dimensions.

Talent 500 has passed tests done in our technical department as well as the tests done in AIDIMA the Technological Institute for furniture. The tests correspond to:

- **UNE-EN 15372:2017.** Furniture. Strength, durability and safety. Requirements for non-domestic tables.
- **GS-CERTIFIED.** Product in compliance with the product safety law with regard to the guarantee of safety and health.