



Sedia con braccioli e struttura in massello di noce canaletta e sedile imbottito con rivestimento nei tessuti della collezione.

Chair with arms and frame in solid canaletta walnut and seat covered in the fabrics of the collection.

Armlehnstuhl aus massivem Nussbaum canaletta. Sitzfläche bezogen in den Stoffen und Leder aus der Kollektion.

Chaise avec accoudoirs et structure en noyer canaletta et assise rembourrée. Revêtement dans les tissus de la collection.

Silla con brazos y estructura de nogal canaletta macizo y asiento revestido en las telas de la colección.

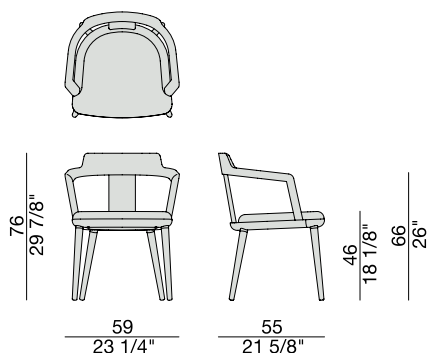

ESSENZE | *Essences*



Noce Canaletta
Canaletta Walnut

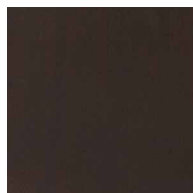

Noce Canaletta
Canaletta Walnut
tinto/stained moka

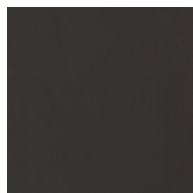

Noce Canaletta
Canaletta Walnut
tinto/stained wengé

LACCATO OPACO PORO CHIUSO | *Matt lacquered closed pore*



Bianco
White
(RAL 9016)

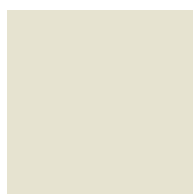

Avorio
Ivory
(RAL 1013)



Argilla
Mud
(RAL 7006)



Piombo
Lead
(NCS S5005G20Y)



Cioccolato
Chocolate
(RAL 8019)

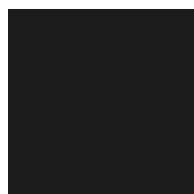

Nero
Black
(RAL 9005)



Granata
Garnet red
(NCS S4050Y90R)



Pistacchio
Pistachio green
(PANTONE 5825)



Avio
Aviation blue
(PANTONE 5415)

PELLE | *Leather*

Categoria LUX



Nabuk

Categoria PLUS



Pelle PLUS

Categoria PELLE



Pelle

Categoria EXTRA

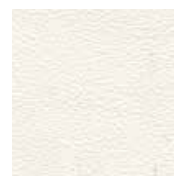

Pelle EXTRA

RIVESTIMENTO | Cover

Categoria A



Hallingdal 65

Categoria B



Rabat



Milord

Categoria C



Fashion



Moran



Thalys

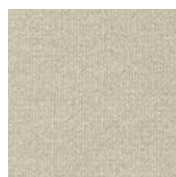

Velvet



Wool



Flax



Armam



Ikat



Loom

Categoria D



Astra

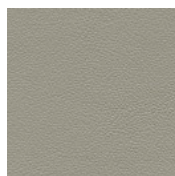

Ecopelle



Range



Tress

Categoria E

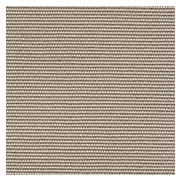

Cotone



Dorian



In Bianco/Calico

Categoria COM

Disponibile con tessuto fornito dal cliente.

Available with fabric supplied by the customer.

Verfügbar mit Kundenstoff.

Disponibile avec tissu du client.

Disponibile con tela suministrada por el cliente.