

design — Gianluigi Landoni



Torso, 837/AI-GAS sgabello \ stool

Torso è una collezione composta da tavoli e sgabello. I tavoli sono proposti nelle versioni con piano tondo e struttura centrale in massello di frassino o noce Canaletto, con dettagli dei piedini e degli anelli in metallo, oppure con piano rettangolare con doppia base in massello di frassino o noce Canaletto, con dettagli metallici dei piedini e degli anelli intorno alle gambe. Il piano può essere in frassino, nelle finiture di collezione, noce Canaletto o vetro. Lo sgabello, semplice ma sofisticato, è costituito da una gamba centrale metallica girevole e una seduta imbottita disponibile nei rivestimenti di collezione. Dotato di pratico poggiatepiedi, presenta inoltre un sistema a gas che permette di regolarne l'altezza.

Torso is a collection of tables and stool. The tables are available in the versions with round top and central base in solid ash wood or Canaletto walnut with details of the feet and rings in metal, or with rectangular top with double base in solid ash wood or Canaletto walnut with metal details of the feet and rings around the legs. The top can be in ash wood, in the finishes as per collection, Canaletto walnut or glass. The stool, sophisticated and simple, has a swivel central metal leg and upholstered seat coated in the coverings as per collection. Torso is also fitted with a practical footrest, and has a gas-height adjustment system.

Informazioni tecniche \ *Technical information*

Descrizione tecnica \ *Technical description*

Sgabello con base centrale girevole in metallo tonda o quadrata con regolazione a gas. Finiture e rivestimenti di collezione.

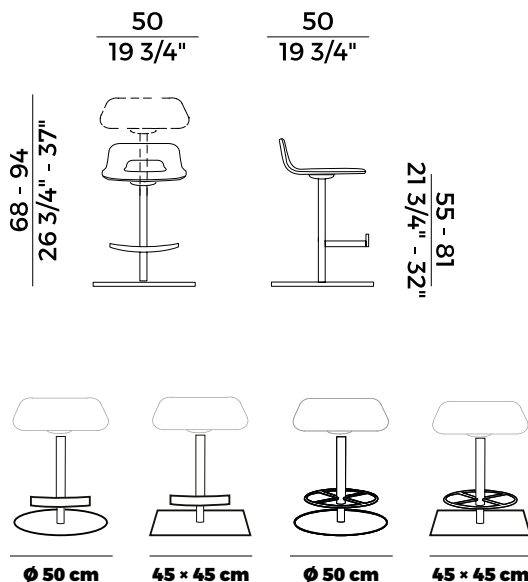

Stool with round or square metal swivel central base with gas height adjustment system. Materials and coverings as per collection.

Dimensioni \ *Dimensions*





Consumi stoffe \ *Fabric and leather requirements*

FABRIC / LEATHER REQUIREMENTS

	x1	x2
 H 140	ml 0,70	ml 1,40
 LEATHER	m ² 1,20	

FABRIC / LEATHER REQUIREMENTS

	x1	x2
 H 140	yd 0.80	yd 1.55
 LEATHER	ft ² 13	



PACKAGING

1 x crt = m ³ 0.33
gross weight - Kg 24

Finiture \ *Finishes*

Finiture struttura \

Frame finishes

Metallo \ *Metal*

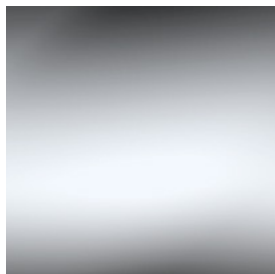

Cromato \
Chrome



Ottone brunito \
Bronzed Brass

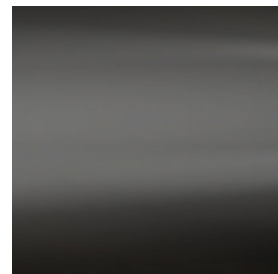

Cromo nero \
Black Chrome

Rivestimenti \

Coverings

Tessuto, ecopelle, pelle \ *Fabric, eco-leather, leather*

**Collezione Torso **

Torso collection

Collezione di arredi composta da sgabello e tavoli.

Sgabello con base centrale girevole in metallo tonda o quadrata con regolazione a gas.

Tavolo con base in massello di frassino o noce Canaletto e dettagli in metallo. Disponibile tondo con base singola e rettangolare con doppia base. Piano in frassino, noce Canaletto o vetro.

Finiture e rivestimenti di collezione.

Collection of furnishings composed of stool and tables.

Stool with round or square metal swivel central base with gas height adjustment system.

Table with solid ash wood or Canaletto walnut base and metal elements. Available round with single base and rectangular with double base. Top in ash wood, Canaletto walnut or glass.

Materials and coverings as per collection.

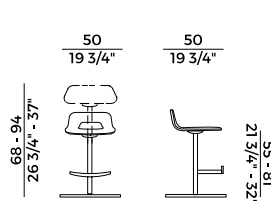

837/AI-GAS

sgabello \ stool

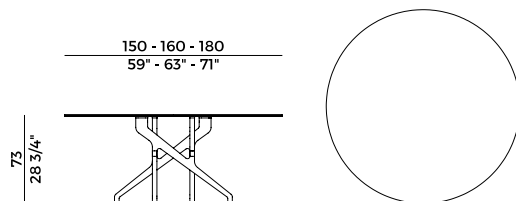

837/T4

tavolo \ table

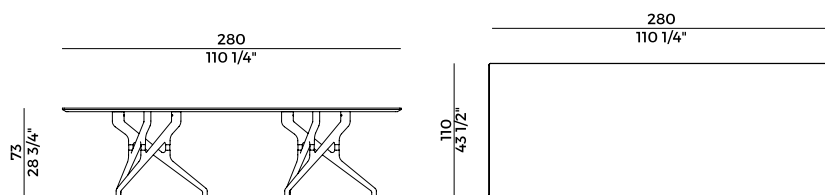

837/TR

tavolo \ table